



*Our Aim To Provide Quality Instruments*



PROFESSIONAL DENTAL INSTRUMENTS

[WWW.VAKMAN.COM.PK](http://WWW.VAKMAN.COM.PK)

# PREFACE

Dear Readers,

“Greetings of Peace from VAKMAN”

On behalf of entire team of Vakman Industries I am feeling great pleasure to present our complements to your good self and your colleagues at your esteemed institution.

Vakman was instituted with the ethos to provide high quality engineered instruments to empower surgical professionals to carry out procedures with precision and trust. Our design and manufacturing pivots around the focus of taking responsibility of the patient at the end of the supply chain.

Vakman is an offshoot of a market leader, Enika Surgical Mfg Co., by bringing together its finest talent under a new platform to deliver our ethos. Headed by Mr. Daud Nasir and Mr. Nasir Ahmed, a duo, based on a combination of excellence in customer services with pioneer in technical design and manufacturing, Vakman has over 35 years of experience in delivering high quality surgical instruments.

Mr. Nasir Ahmed is known in the industry for not only having designed standard instruments but also to help surgeon develop cutting edge instruments for their specialist needs. Under his leadership we are proud to boast that we have a workforce made up of select industry leading technologist, advanced & proven manufacturing processes governed by evolved and strict quality practices.

All Vakman manufacturing facilities are certified by international bodies like ISO 13485 and ISO 9001.

At Vakman, we take our conformance to these standards as our priority and a commitment to our patient's safety. Our focus is not on mass producing and selling rather we take pride in manufacturing to design, supporting the surgical industry in development of new methods and tools to support those methods. We are continuously partnering with leading practitioners and in this partnership we serve as their contract development and manufacturing organization. These partnerships have been developed over decades of trust and successful delivery.

We welcome you to join us in our partnership where patient safety and cutting edge technology are the foundations of our relationship.

Daud Nasir

CEO

VAKMAN INDUSTRIES



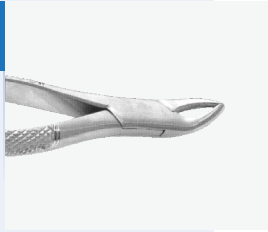

Extracting Forceps

Page 01-31

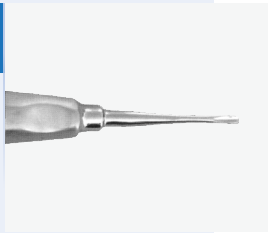

Root Elevators

Page 32-51

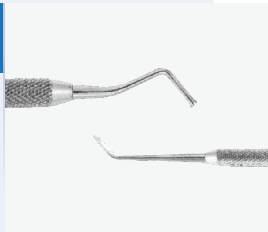

Filling Instruments

Page 52-56

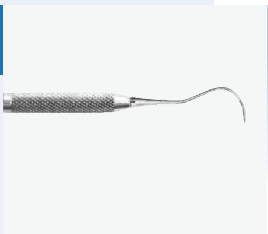

Dental Probes

Page 57-60

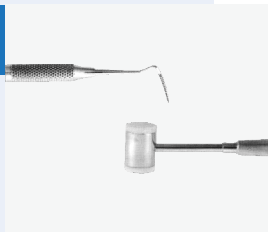

Periodontia Instruments  
& Mallets

Page 61-68

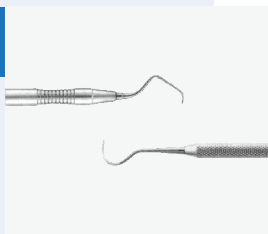

Curettes & Scalers

Page 69-75

Page 76 - 78

Modelling & Measuring  
Instruments



Page 79 - 80

Wax / Plaster Knives



Page 81 - 86

Diagnostic (Explorers) &  
Endodontic Instruments

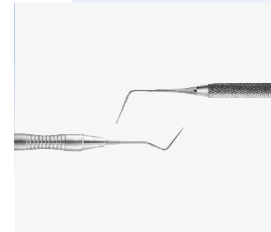

Page 87 - 88

Excavators

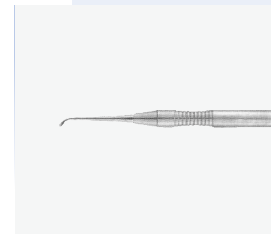

Page 89 - 90

Handles For Mouth Mirrors  
& Mouth Mirrors

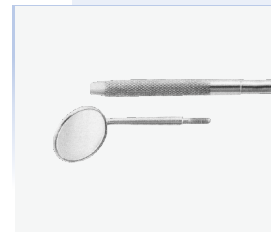

Page 91 - 94

Spatulas





Needle Holders &  
Saliva Ejectors

Page 95 - 101



Syringes

Page 102 - 105



Scissors

Page 106 - 110



Dental Tweezers

Page 111 - 115

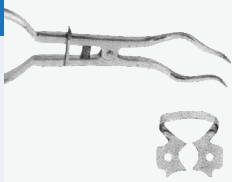

Rubber Dam Clamps

Page 116 - 118



Matrix Retainers &  
Matrix Bands

Page 119 - 120



Crown Removers, Scissors,  
Forceps, Amalgum Guns & Carriers

Page 121 - 123

TABLE OF CONTENTS



Page 124

Copper Ring Removing Pliers  
& Paper Articulating Forceps



Page 125 - 128

Rongeurs

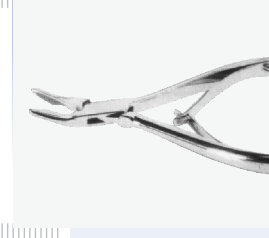

Page 129 - 130

Bone Elevators,  
Files & Chisels

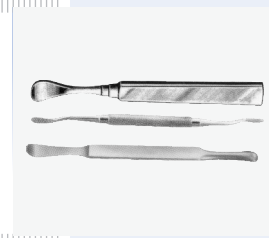

Page 131 -152

Pliers For Orthodontics & Prosthetics  
Mouth Gags  
Lip and Cheek Retractors  
Retractors  
Implantology Instrumentns

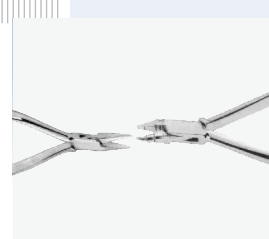

Page 153 -156

Impression Trays



Page 157 - 158

Articulators

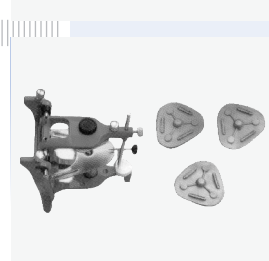

Page 159 - 161

Hollowares

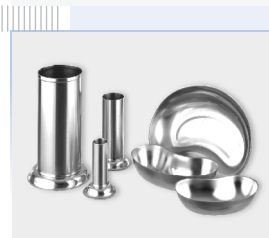





**VAKMAN**  
INDUSTRIES

01

# Page 1-31

- Extracting Forceps - English Pattern



**VI-1001**  
Fig 8  
lower premolars



**VI-1002**  
Fig 13  
lower premolars

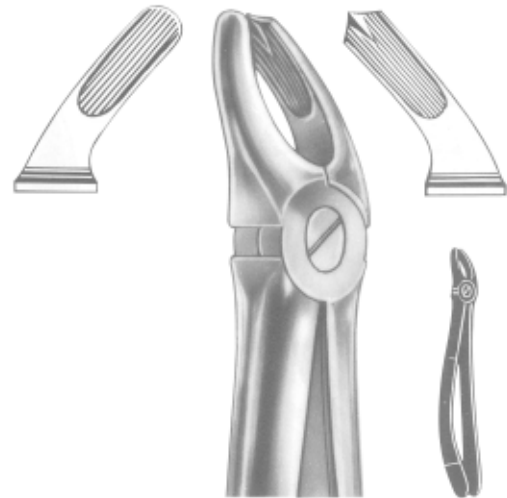

**VI-1003**  
Fig 17  
upper molars, right

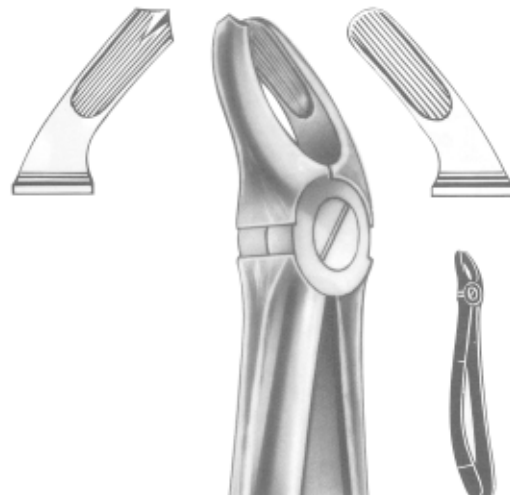

**VI-1004**  
Fig 18  
upper molars, left

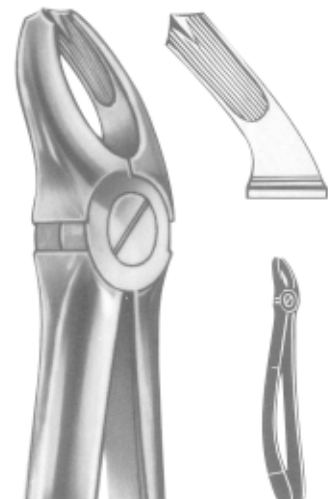

**VI-1005**  
Fig 18 A  
upper molars

Extracting Forceps - English Pattern



**VI-1006**  
Fig 19  
upper wisdoms

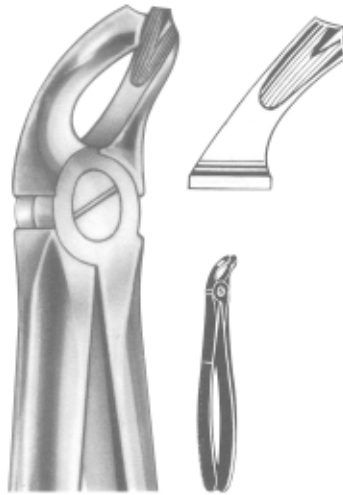

**VI-1007**  
Fig 20  
lower wisdoms

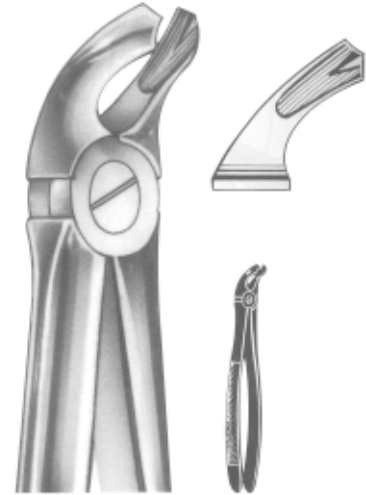

**VI-1008**  
Fig 21  
lower molars



**VI-1009**  
Fig 22  
lower molars

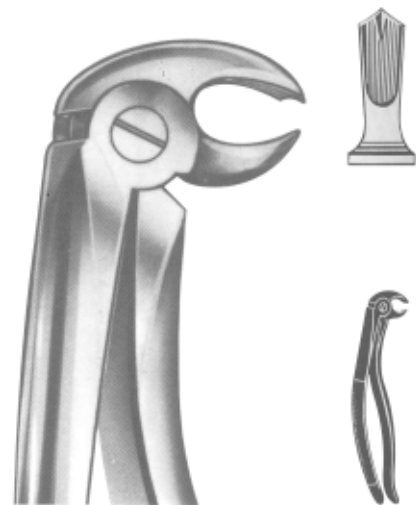

**VI-1010**  
Fig 22 A  
Albrecht  
lower molars



**VI-1011**  
Fig 33 A  
lower roots

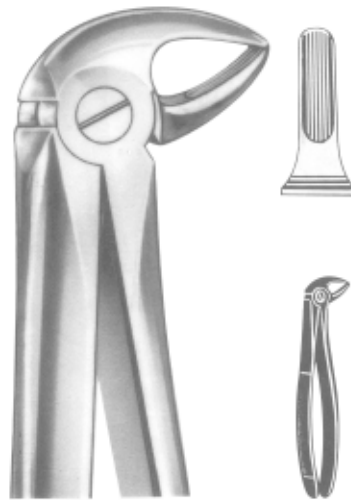

**VI-1012**  
Fig 33 B  
lower roots

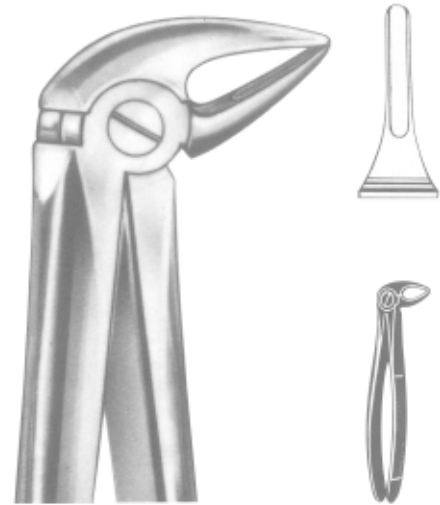

**VI-1013**  
Fig 33 L  
lower roots



**VI-1014**  
Fig 33 L  
lower roots



**VI-1015**  
Fig 33 S  
lower roots, for children



Extracting Forceps - English Pattern

01



**VI-1016**  
Fig 44  
upper roots

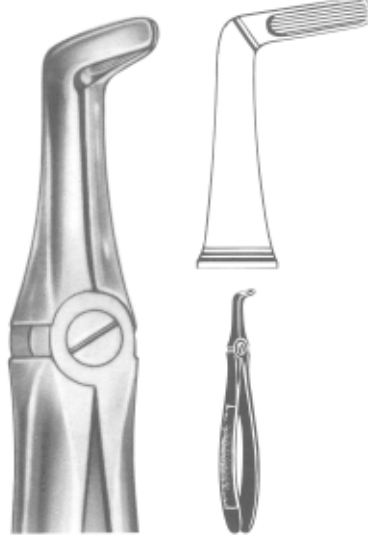

**VI-1017**  
Fig 45  
lower roots

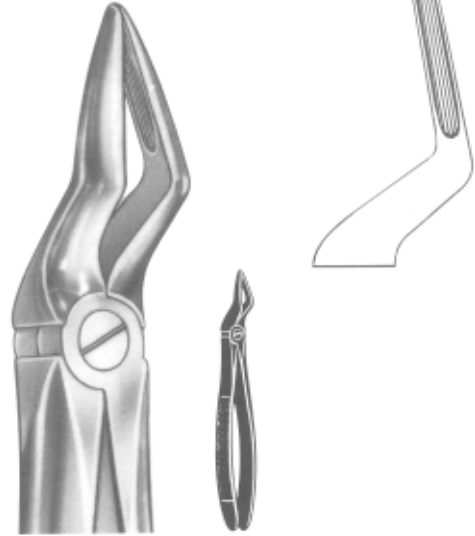

**VI-1018**  
Fig 12  
upper roots

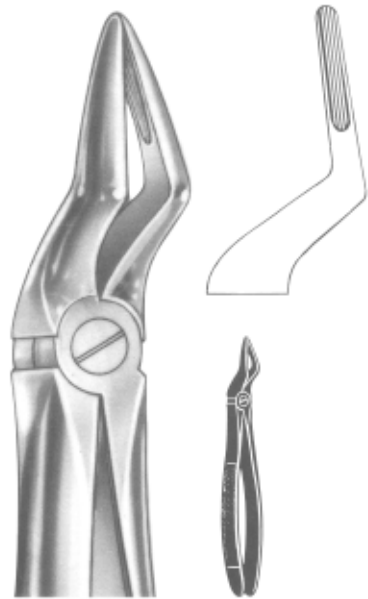

**VI-1019**  
Fig 51 A  
upper roots

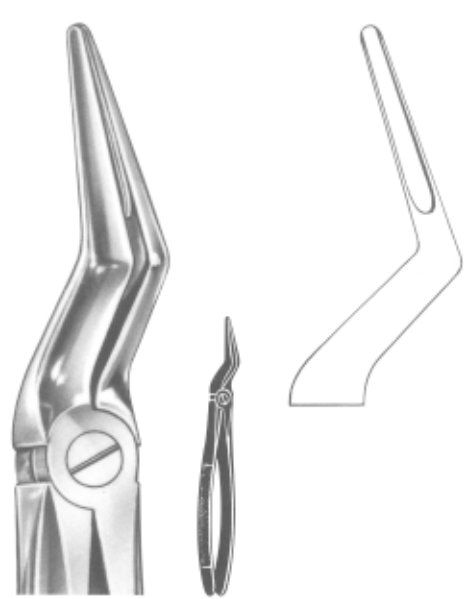

**VI-1020**  
Fig 51 L  
upper roots



**Relax  
VI-1021**  
Fig 51  
upper roots

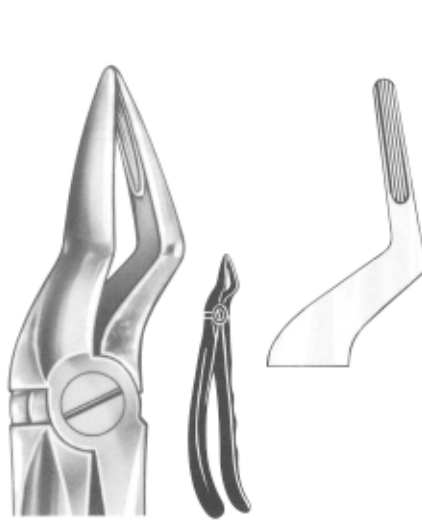

**Relax  
VI-1022**  
Fig 51 A  
upper roots

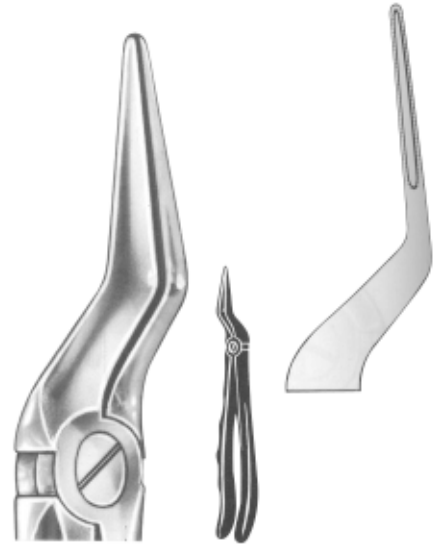

**Relax  
VI-1023**  
Fig 51 L  
upper roots

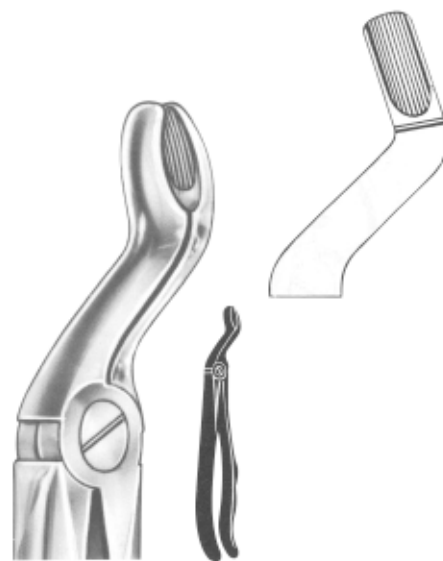

**Relax  
VI-1024**  
Fig 67  
upper wisdoms

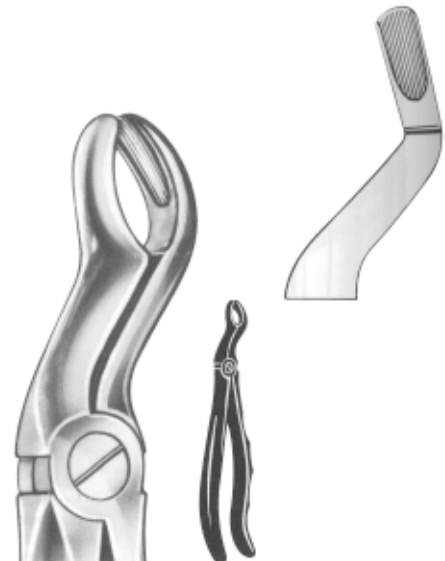

**Relax  
VI-1025**  
Fig 67 A  
upper wisdoms

Extracting Forceps For Children - English Pattern

01



**VI-1026**  
Fig 37  
Upper incisors



WITH SERRATED  
TIPS

**VI-1027**  
Fig 39  
Upper molars



WITH SERRATED  
TIPS

**VI-1028**  
Fig 39 R  
Upper molars, right



WITH SERRATED  
TIPS

**VI-1029**  
Fig 39 L  
Upper molars, left



WITH SERRATED  
TIPS

**VI-1030**  
Fig 515  
Upper roots



**Klein  
VI-1032**  
Fig 137  
upper incisors



**Klein  
VI-1031**  
Fig 6  
lower molars



**Klein  
VI-1033**  
Fig 5  
lower incisors

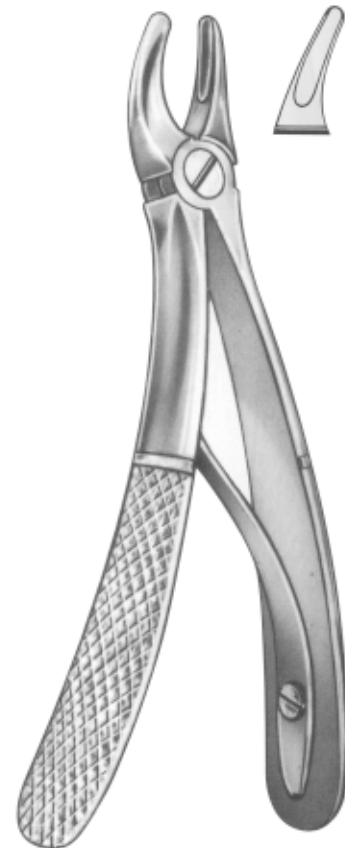

**Klein  
VI-1034**  
Fig 139  
uper premolars





**VI-1035**  
Fig 43 A  
Fractured or decayed  
upper teeth

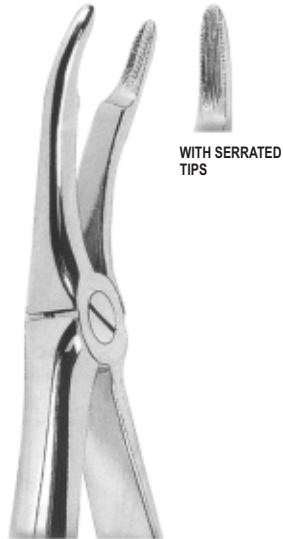

**VI-1036**  
Fig 44  
Upper roots



**VI-1037**  
Fig 45  
Lower roots

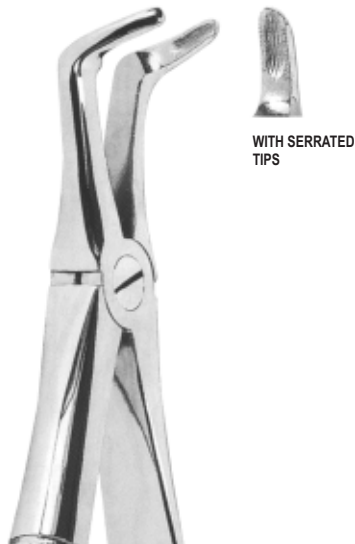

**VI-1038**  
Fig 46  
Lower roots



**VI-1039**  
Fig 46 L  
Lower roots



**VI-1040**  
Fig 48  
Upper roots



WITH SERRATED TIPS



**VI-1041**  
Fig 51  
Upper roots



WITH SERRATED TIPS



**VI-1042**  
Fig 49  
Upper roots



WITH SERRATED TIPS



**VI-1043**  
Fig 51 L  
Upper roots



WITH SERRATED TIPS



**VI-1044**  
Fig 51 A  
Upper roots



WITH SERRATED TIPS

Extracting Forceps - English Pattern



**VI-1045**  
Fig 51 LX  
Upper roots



**VI-1046**  
Fig 52  
Upper roots and  
canines



**VI-1047**  
Fig 54  
For separating  
upper molars



**VI-1048**  
Fig 55  
For separating  
upper molars



**VI-1049**  
Fig 56  
For separating  
lower molars

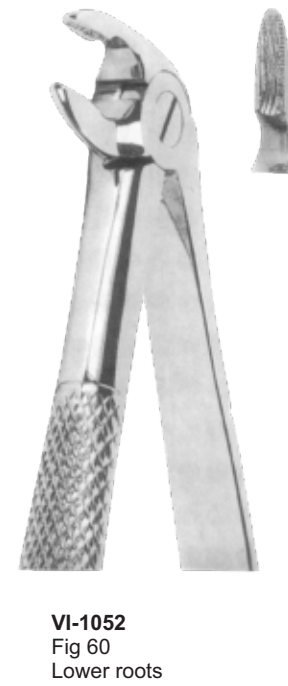
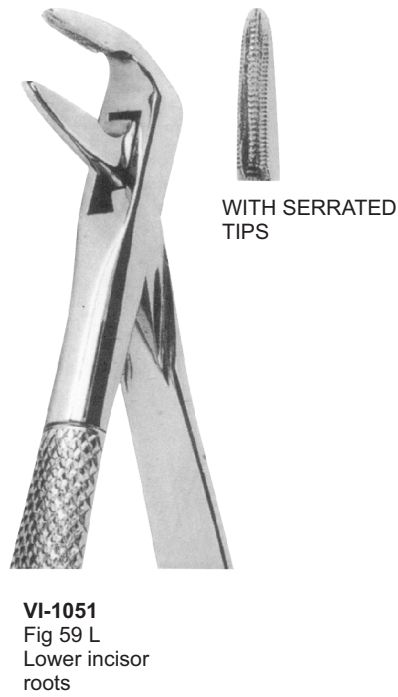



Extracting Forceps - English Pattern

01



**VI-1055**  
Fig 66 L  
Upper molars, left



WITH SERRATED TIPS



**1056**  
Fig 66 R  
Upper molars, right



WITH SERRATED TIPS



**VI-1057**  
Fig 67  
Upper third molars



WITH SERRATED TIPS



**VI-1058**  
Fig 67 A  
Upper third molars



WITH SERRATED TIPS



**VI-1059**  
Fig 68  
Lower roots



WITH SERRATED TIPS



**VI-1060**  
Fig 67½ L  
Upper third molars, left



**VI-1061**  
Fig 67½ R  
Upper third molars, right



**VI-1062**  
Fig 73  
Lower molars



**VI-1063**  
Fig 74  
Lower roots

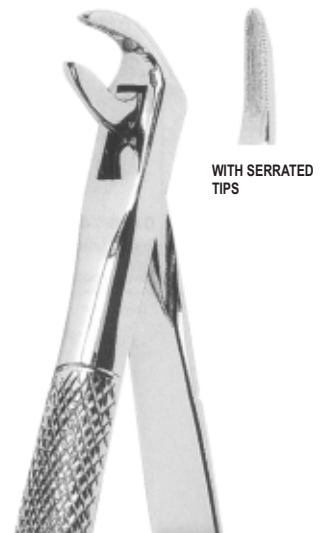

**VI-1064**  
Fig 74 M  
Lower roots

Extracting Forceps - English Pattern



**VI-1065**  
Fig 74 N  
Lower roots



**VI-1066**  
Fig 75  
Lower canines and  
premolars

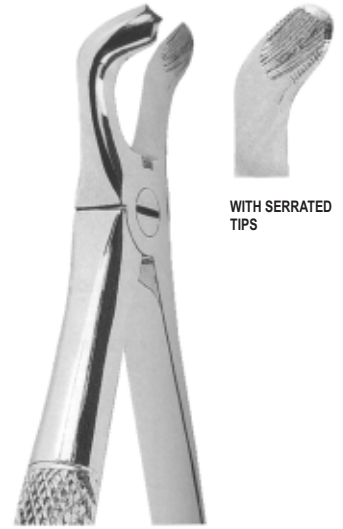

**VI-1067**  
Fig 79  
Lower third molars



**VI-1068**  
Fig 79 A  
Lower third molars



**VI-1069**  
Fig 79 C  
Lower third molars



**VI-1070**  
Fig 86 W  
Lower third molars



**VI-1071**  
Fig 86 1/2 L  
Lower third molars, left



**VI-1072**  
Fig 86 1/2 R  
Lower third molars, right



**VI-1073**  
Fig 86 C  
Lower molars

Extracting Forceps - English Pattern



**VI-1074**  
Fig 87  
Lower decayed molars  
or broken-down crowns



WITH SERRATED  
TIPS

**VI-1075**  
Fig 89  
Upper molars, right



WITH SERRATED  
TIPS

**VI-1076**  
Fig 90  
Upper molars, left



WITH SERRATED  
TIPS

**VI-1077**  
Fig 99  
Broken-down lower molars

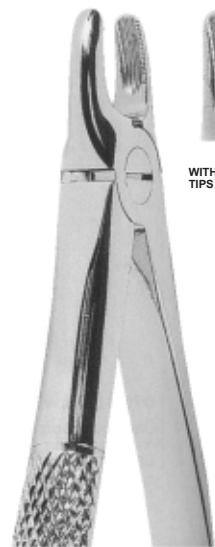

WITH SERRATED  
TIPS

**VI-1078**  
Fig 107  
Upper canines



**VI-1079**  
Fig 121  
Upper third molars



**VI-1080**  
Fig 145  
Lower roots



**VI-1081**  
Fig 151½  
Upper roots

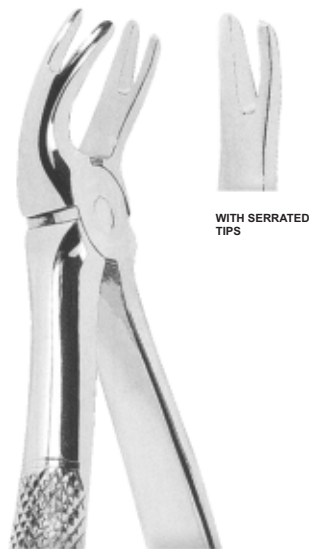

**VI-1082**  
Fig 166  
Universal extracting forceps for  
upper teeth, in particular molars  
and premolars



**VI-1083**  
Fig 167  
Universal extracting forceps for  
lower teeth, in particular molars  
and premolars

Extracting Forceps - English Pattern



WITH SERRATED TIPS

**VI-1084**  
Fig 168  
Upper canines



WITH SERRATED TIPS

**VI-1085**  
Fig 169  
Lower canines

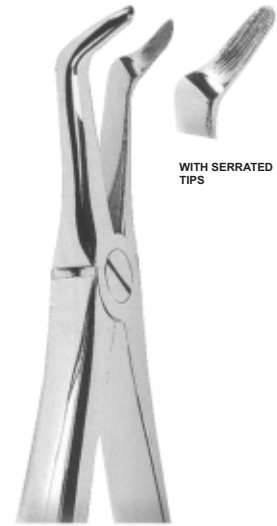

WITH SERRATED TIPS

**VI-1086**  
Fig 346  
Lower roots



WITH SERRATED TIPS

**VI-1087**  
Fig 349  
Upper roots



WITH SERRATED TIPS

**VI-1088**  
Fig 359  
Lower roots





**VI-1089**  
Fig 1  
Universal extracting forcep for upper incisors and canines



WITH SERRATED TIPS

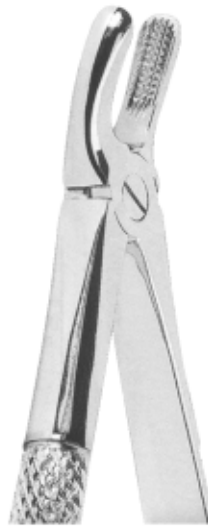

**VI-1090**  
Fig 2  
Upper molars



WITH SERRATED TIPS

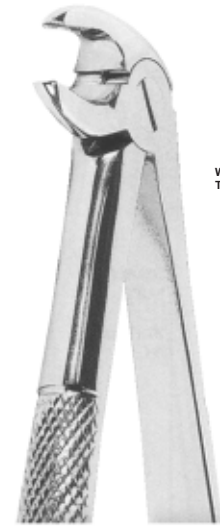

**VI-1091**  
Fig 3  
Lower incisors, premolar and roots



WITH SERRATED TIPS



**VI-1092**  
Fig 4  
Lower molars



WITH SERRATED TIPS



Extracting Forceps With Anatomically Shyped Handle



**VI-1093**  
Fig 1  
Upper incisors  
and canines

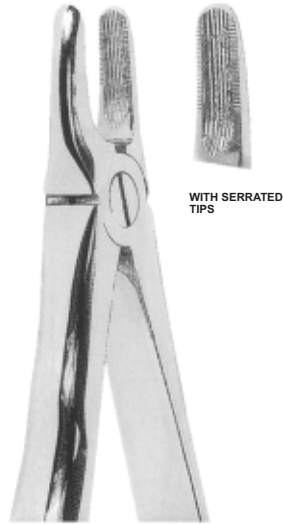

**VI-1094**  
Fig 2  
Upper incisors  
and canines

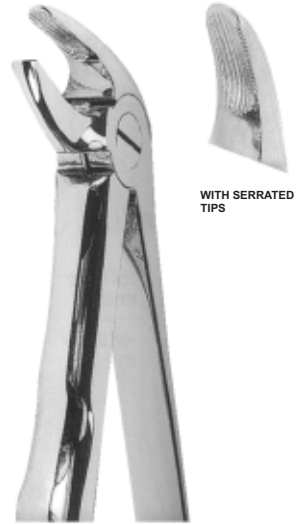

**VI-1095**  
Fig 4  
Lower incisors  
and canines



**VI-1096**  
Fig 7  
Upper premolars



**VI-1097**  
Fig 13  
Lower premolars



**VI-1098**  
Fig 17  
Upper molars, right



**VI-1099**  
Fig 18  
Upper molars, left

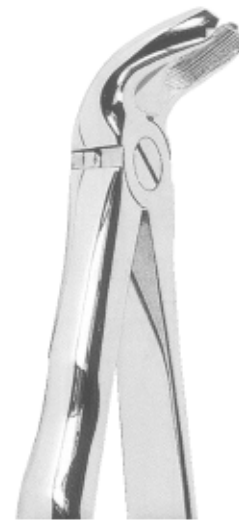

**VI-1100**  
Fig 21  
Lower molars



**VI-1101**  
Fig 22  
Lower molars



**VI-1102**  
Fig 33  
Lower roots



Extracting Forceps With Anatomically Shyped Handle

01



**VI-1103**  
Fig 45  
Lower roots



WITH SERRATED TIPS



WITH SERRATED TIPS

**VI-1104**  
Fig 51 A  
Upper roots



WITH SERRATED TIPS

**VI-1105**  
Fig 67 A  
Upper third molars



WITH SERRATED TIPS

**VI-1106**  
Fig 74  
Lower roots

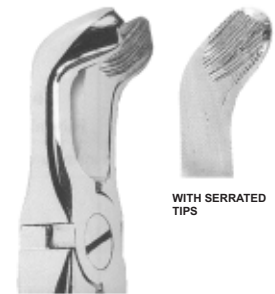

WITH SERRATED TIPS

**VI-1107**  
Fig 79  
Lower third molars



WITH SERRATED TIPS

**VI-1108**  
Fig 86 C  
Lower molars



WITH SERRATED TIPS

**VI-1109**  
Fig 359  
Lower roots



**VI-1110**  
Fig 89  
Upper molars, right



**VI-1111**  
Fig 90  
Upper molars, left

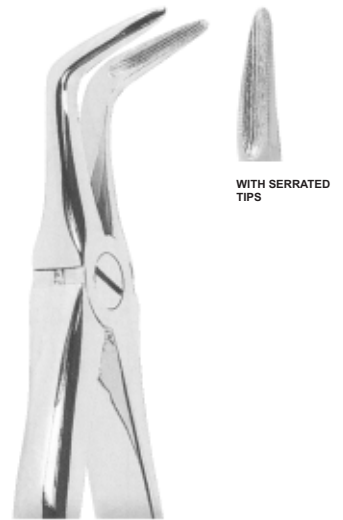

**VI-1112**  
Fig 145  
Lower roots



**VI-1113**  
Fig 151 ½  
Upper roots

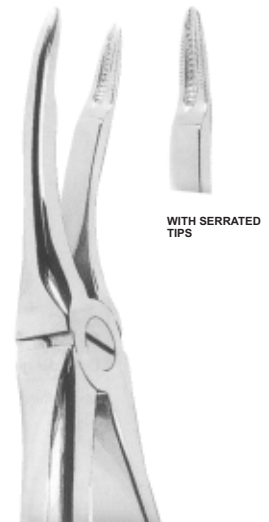

**VI-1114**  
Fig 349  
Upper roots

Extracting Forceps - American Pattern

01



**VI-1115**  
Fig 5  
Lower third molars



**VI-1116**  
Fig 6  
Separating forcep



**VI-1117**  
Fig 105  
Upper molars



**VI-1118**  
Fig 16  
Lower molars



**VI-1119**  
Fig 17  
Lower molars



**VI-1120**  
Fig 18 L  
Upper molars, left



**VI-1121**  
Fig 18 R  
Upper molars, right



**VI-1122**  
Fig 23  
Lower molars



**VI-1123**  
Fig 53 R  
Upper molars, right



**VI-1124**  
Fig 53 L  
Upper molars, left

Extracting Forceps - American Pattern



**VI-1125**  
Fig 65  
Upper incisors and roots



**VI-1126**  
Fig 69  
Upper and lower roots



**VI-1127**  
Fig 88 R  
Upper molars, right



**VI-1128**  
Fig 88 L  
Upper molars, left



**VI-1129**  
Fig 101  
Deciduous teeth





**VI-1130**  
Fig 150  
Upper incisors, premolars, roots



**VI-1131**  
Fig 150 S  
Upper teeth (for children)



**VI-1132**  
Fig 151  
Upper incisors, premolars, roots



**VI-1133**  
Fig 151S  
Lower teeth (for children)

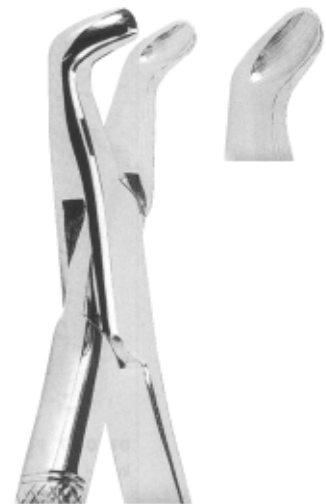

**VI-1134**  
Fig 222  
Lower third molars

Extracting Forceps - American Pattern

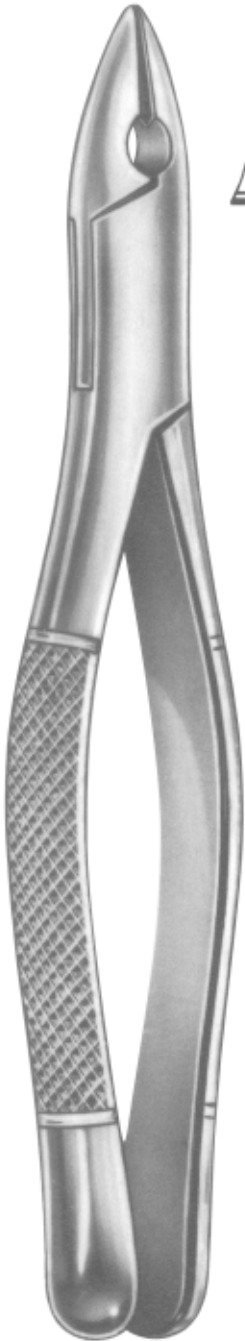

**VI-1135**  
Fig 1  
upper incisors and bicuspid



**VI-1136**  
Fig 1 B  
upper roots, anterior



**Physick**  
**VI-1137**  
Fig 5  
lower wisdoms



**VI-1138**  
Fig 6  
lower molars, splitting forceps



**VI-1139**  
Fig 10 H  
upper molars





WITH SERRATED TIPS

**VI-1140**  
Fig 135  
Lower premolars



**VI-1141**  
Fig 225  
Lower molars



**VI-1142**  
Fig 305  
Upper incisors  
and roots



WITH SERRATED TIPS

**VI-1143**  
Fig 33 S  
Lower roots



WITH SERRATED TIPS

**VI-1144**  
Fig 38  
Lower incisors  
and canines

Extracting Forceps For Children - Klein Pattern



**VI-1145**  
Fig 1  
Upper incisors



WITH SERRATED TIPS



**VI-1146**  
Fig 2  
Upper permolars

WITH SERRATED TIPS



**VI-1147**  
Fig 3  
Upper molars

WITH SERRATED TIPS



**VI-1148**  
Fig 4  
Upper roots

WITH SERRATED TIPS



**VI-1149**  
Fig 5  
Lower incisors

WITH SERRATED TIPS



**VI-1150**  
Fig 6  
Lower molars

WITH SERRATED TIPS



**VI-1151**  
Fig 7  
Lower roots

WITH SERRATED TIPS



**VI-1152**  
Fig 1  
Lower roots



**VI-1153**  
Fig 2  
Upper roots



**VI-1155**  
Fig 2  
Roots fragments



**VI-1154**  
Fig 1  
Roots fragments



**VAKMAN**  
INDUSTRIES

02

## Page 32-60

- Root Elevators, Filling
- Instruments & Dental Probes

lower jaw, left side

lower jaw, right side

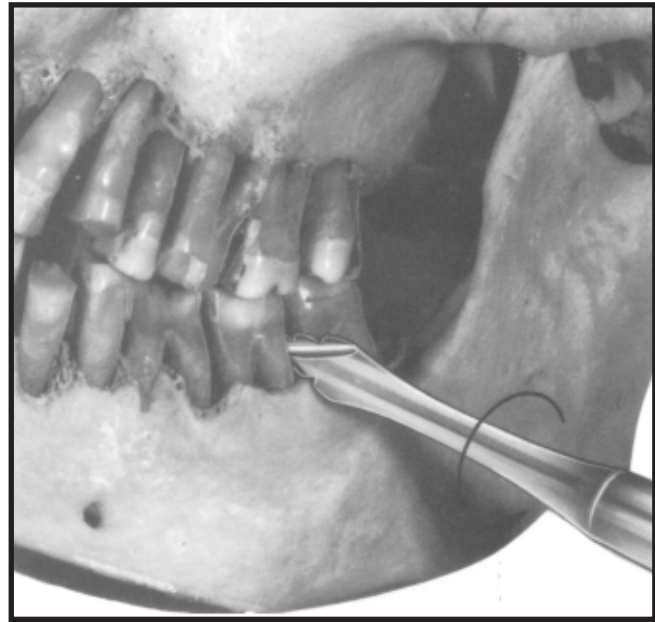

VI-2000



VI-2001

Root elevator, spiral-shaped, for extremely facilitated extraction of the molars in the lower jaw. The slender, conical points allow deep penetration between tooth and gum. Owing to the hook-shaped working parts, slipping of the elevator is avoided.



Root Elevators



Bein

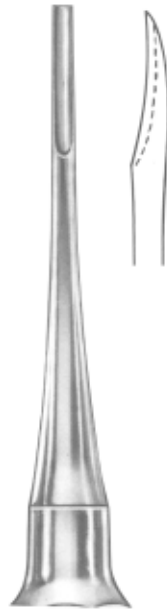

Bein VI-2002 Fig 1



Bein VI-2003 Fig 2

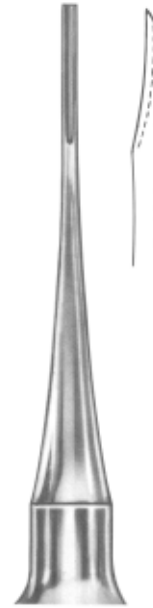

Bein VI-2004 Fig 0



Bein VI-2005 Fig 3

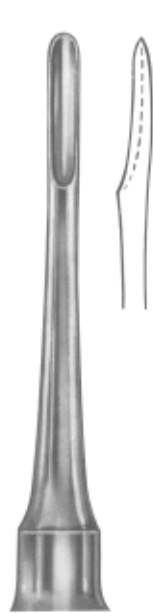

Bein VI-2006 Fig 4

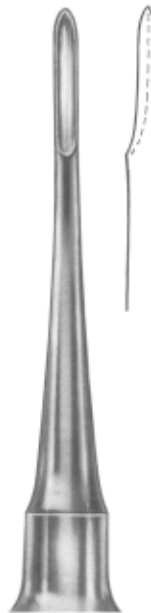

Bein VI-2007 Fig 5

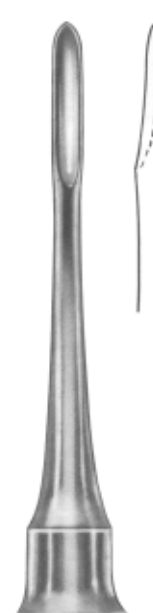

Bein VI-2008 Fig 6



**Seldin**



**Seldin  
VI-2009  
Fig 1L**



**Seldin  
VI-2010  
Fig 1R**



**Seldin  
VI-2011  
Fig 2**



**Seldin  
VI-2012  
Fig 3**



**Seldin  
VI-2013  
Fig 4L**



**Seldin  
VI-2014  
Fig 4R**

Root Elevators



**Cryer  
VI-2015  
Fig 3**



**Cryer  
VI-2016  
Fig 4**



**Cryer  
VI-2017  
Fig 12**



**Cryer  
VI-2018  
Fig 27**



**Cryer  
VI-2019  
Fig 28**



**Cryer  
VI-2020  
Fig 27 S**



**Cryer  
VI-2021  
Fig 28 S**



Apical



Apical  
VI-2022  
Fig 1



Apical  
VI-2023  
Fig 2



Apical  
VI-2024  
Fig 3



Apical  
VI-2025  
Fig 4

Root Elevators



Cryer



Cryer  
VI-2026  
Fig 1



Cryer  
VI-2027  
Fig 2



Coupland



Coupland  
VI-2028  
Fig 1



Coupland  
VI-2029  
Fig 2



Coupland  
VI-2030  
Fig 3



**VI-2031**  
Fig 1

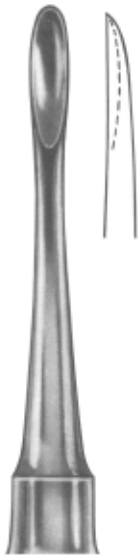

**VI-2032**  
Fig 2

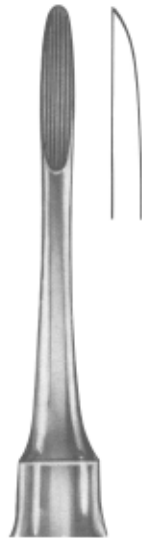

**VI-2033**  
Fig 3



**Flohr**  
**VI-2034**  
Fig 1



**VI-2035**  
Fig 2



**Flohr**  
**VI-2036**  
Fig 3

Root Elevators



Kopp VI-2037 Fig 1



Kopp VI-2038 Fig 2



Kopp VI-2043 Fig 1



Kopp VI-2044 Fig 2



Kopp



Kopp VI-2039 Fig 3



Kopp VI-2040 Fig 4



Kopp



Kopp VI-2045 Fig 3



Kopp VI-2046 Fig 4



Kopp VI-2041 Fig 5



Kopp VI-2042 Fig 6





Hylin



Hylin  
VI-2047  
Fig 1



Hylin  
VI-2048  
Fig 2



Bein

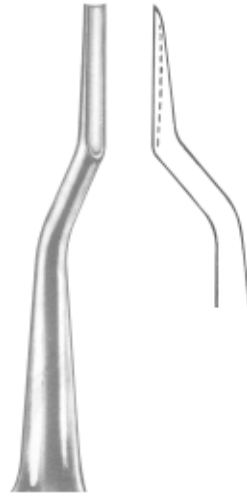

Bein  
VI-2049  
Fig 1

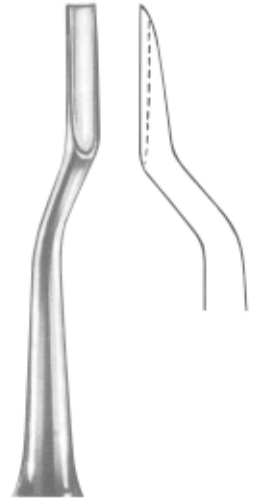

Bein  
VI-2050  
Fig 2



Bein  
VI-2051  
Fig 3

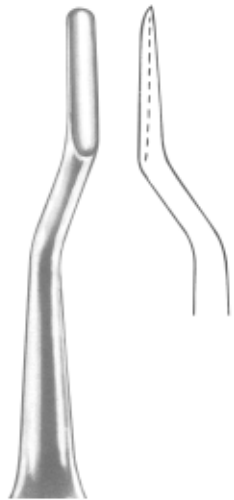

Bein  
VI-2052  
Fig 4

Root Elevators



**Warwick-James  
VI-2053**  
Fig 1



**Warwick-James  
VI-2054**  
Fig 2



**Warwick-James  
VI-2055**  
Fig 3



**London Hospital  
VI-2056**  
Fig 1



**London Hospital  
VI-2057**  
Fig 2



**London Hospital  
VI-2058**  
Fig 3



**Ott  
VI-2059**

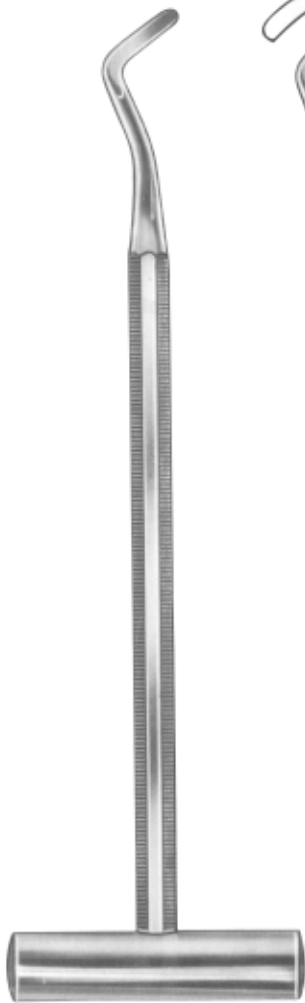

Pott



Pott  
VI-2060  
Fig 1



Pott  
VI-2061  
Fig 2



VI-2062  
Fig 1

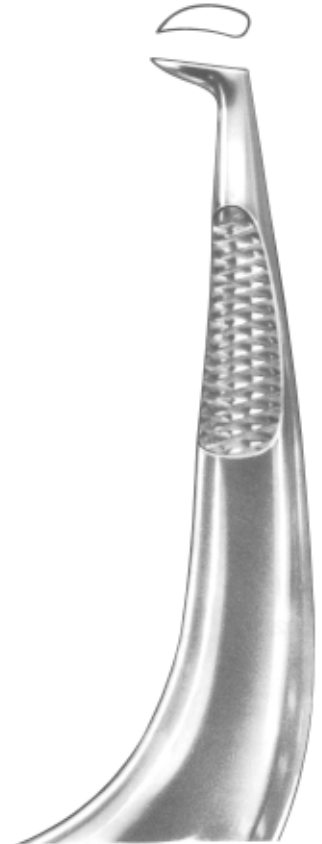

VI-2063  
Fig 2

Root Elevators

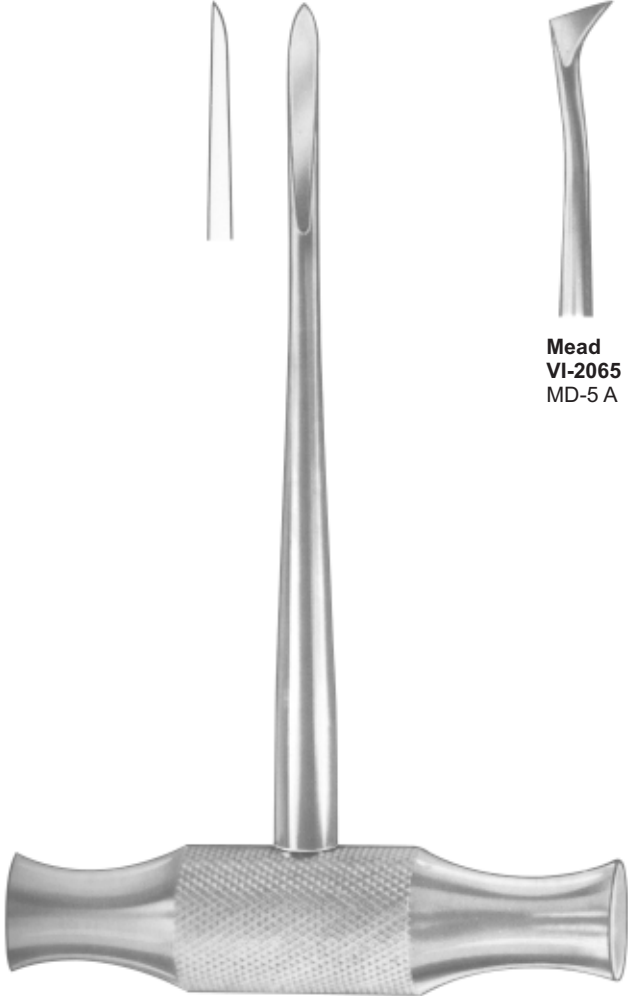

**Mead  
VI-2064  
MD 1**



**Mead  
VI-2065  
MD-5 A**



**Mead  
VI-2066  
MD-6 A**



**Mead  
VI-2067  
MD-7 A**



**Mead  
VI-2068  
MD-8**

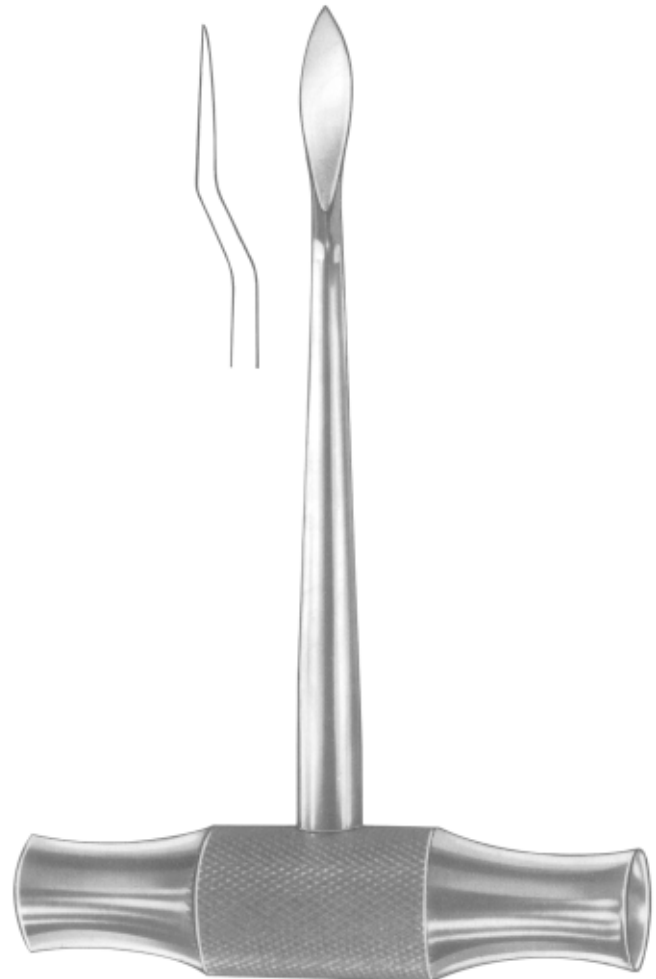

**Lecluse  
VI-2069**



**Chompret  
VI-2070  
Fig 1**



**Chompret  
VI-2071  
Fig 2**



**Chompret  
VI-2072  
Fig 3**



**Chompret  
VI-2073  
Fig 4**



**Apical  
VI-2074**

Root Elevators Root Tip Elevators



**VI-2075**  
Fig 1



**VI-2076**  
Fig 2



**VI-2077**  
Fig 3



**Heidbrink  
VI-2078**  
Fig 1



**Heidbrink  
VI-2079**  
Fig 2



**Heidbrink  
VI-2080**  
Fig 3



Winter  
VI-2081  
Fig 1L



Winter  
VI-2082  
Fig 1R



Winter  
VI-2083  
Fig 2L



Winter  
VI-2084  
Fig 2R



Winter



Winter  
VI-2085  
Fig 11 L



Winter  
VI-2086  
Fig 11 R



Winter  
VI-2087  
Fig 12 L



Winter  
VI-2088  
Fig 12 R



Winter  
VI-6 289  
Fig 14 L



Winter  
VI-2090  
Fig 14 R



Root Elevators



**Barry  
VI-2091  
Fig 1**



**Barry  
VI-2092  
Fig 2**



**Barry  
VI-2093  
Fig 3**



**Barry  
VI-2094  
Fig 4**



**Barry**



**Barry  
VI-2095  
Fig 11**



**Barry  
VI-2096  
Fig 12**



**Barry  
VI-2097  
Fig 17**



**Barry  
VI-2098  
Fig 18**



Cryer  
VI-2100  
Fig 26



Seldin  
VI-2101  
Fig 27



Cryer  
VI-2102  
Fig 28



Cryer  
VI-2103  
Fig 29



Heidbrink  
VI-2104  
Fig 22



Heidbrink  
VI-2105  
Fig 23



VI-2099

Root Elevators



**Kopp  
VI-2107  
Fig 31**



**Kopp  
VI-2108  
Fig 32**



**Kopp  
VI-2109  
Fig 33**



**Kopp  
VI-2110  
Fig 34**



**Kopp  
VI-2111  
Fig 35**



**Kopp  
VI-2112  
Fig 44**



**VI-2106**



**Heidbrink  
VI-2114  
Fig 10**



**Winter  
VI-2115  
Fig 11**



**Winter  
VI-2116  
Fig 12**



**Barry  
VI-2117  
Fig 17**



**Barry  
VI-2118  
Fig 18**



**VI-2119  
Fig 20**



**VI-2113**

Root Elevators

Root Elevators according to Dr. Sader,  
with interchangeable working tips



VI-2121



VI-2120



VI-2122

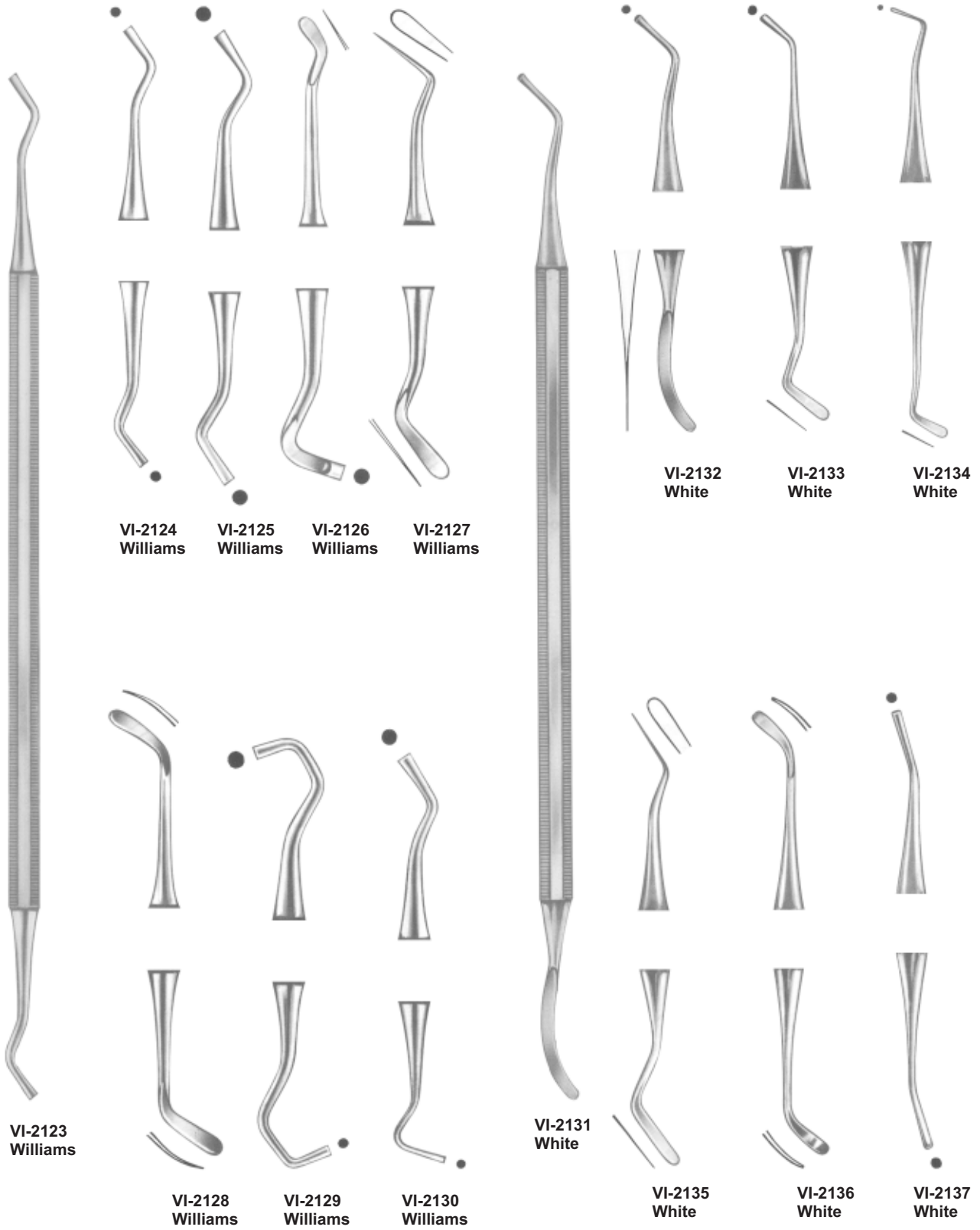

VI-2124 Williams  
 VI-2125 Williams  
 VI-2126 Williams  
 VI-2127 Williams

VI-2132 White  
 VI-2133 White  
 VI-2134 White

VI-2123 Williams

VI-2131 White

VI-2128 Williams  
 VI-2129 Williams  
 VI-2130 Williams

VI-2135 White  
 VI-2136 White  
 VI-2137 White

Filling Instruments

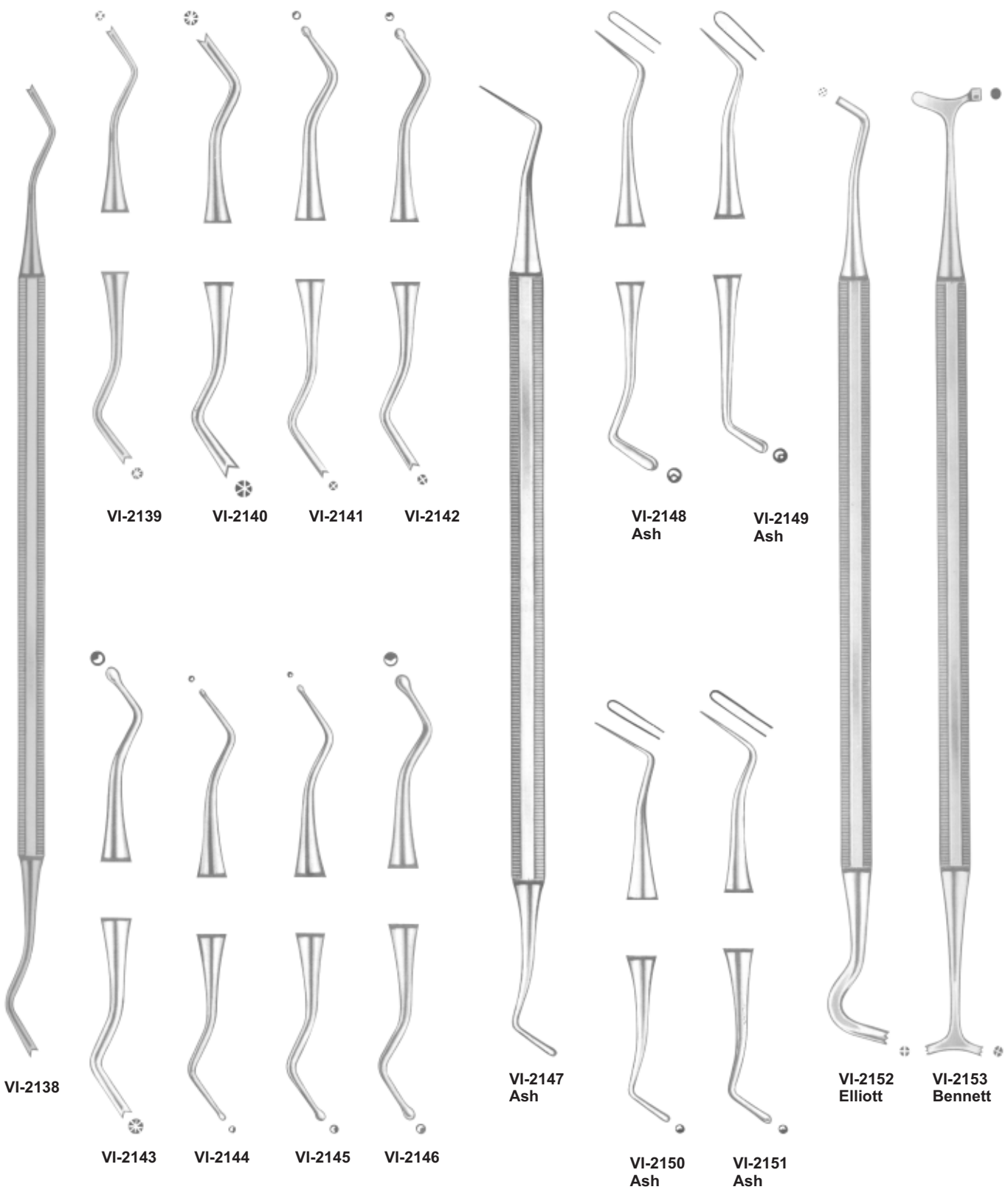



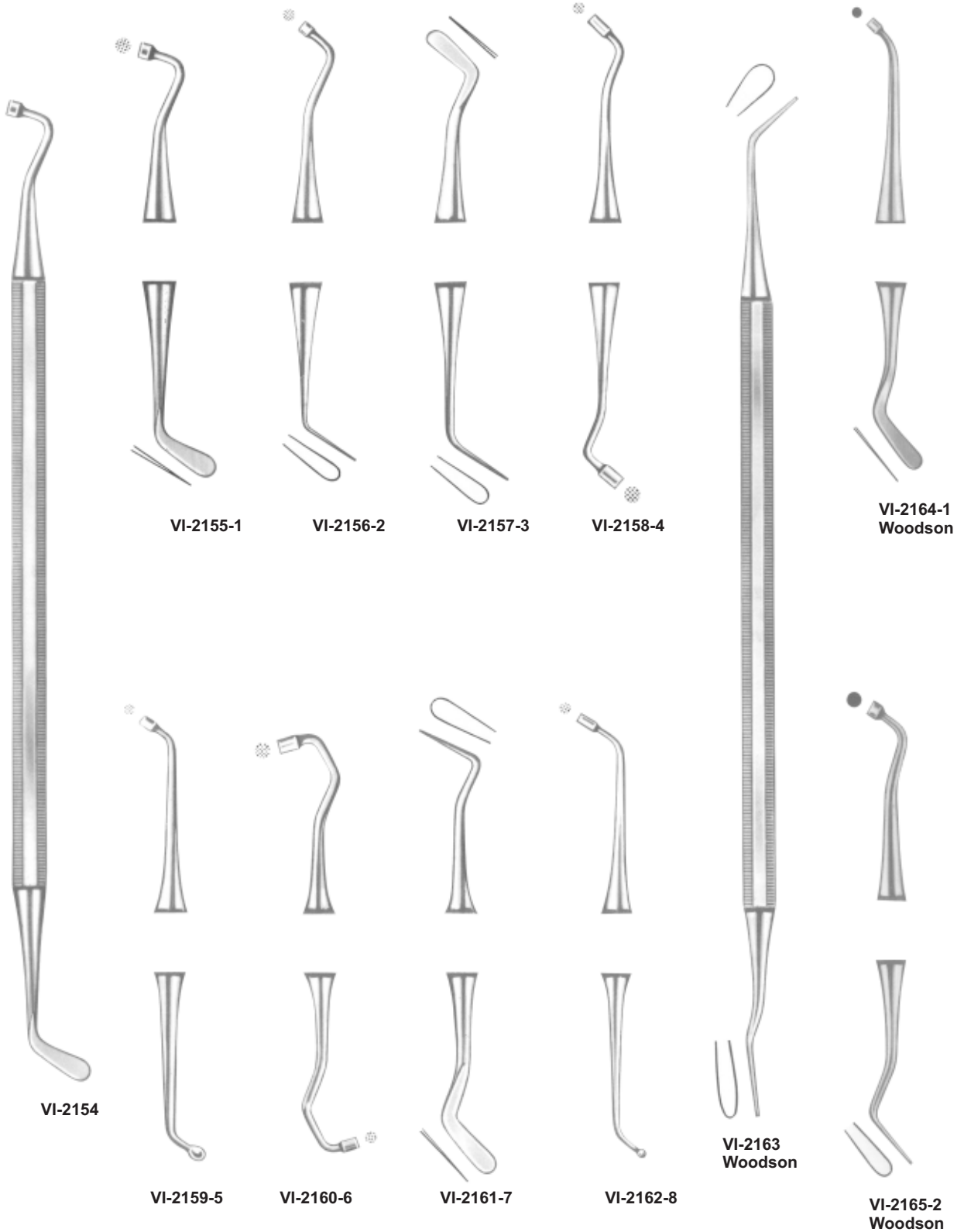

Filling Instruments

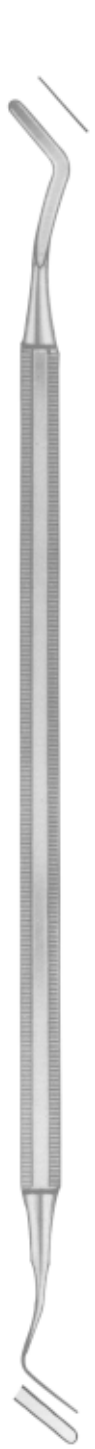

VI-2166  
Heidemann  
Fig 1



VI-2167  
Heidemann  
Fig 2



VI-2168  
Heidemann  
Fig 3

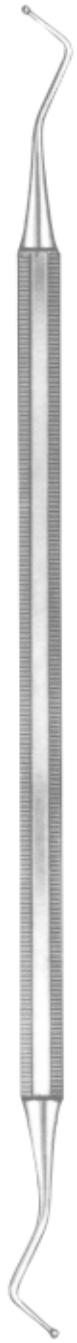

VI-2169



VI-2170  
Fig 146



VI-2172  
Fig 148



VI-2171  
Fig 147



VI-2173  
Fig 149

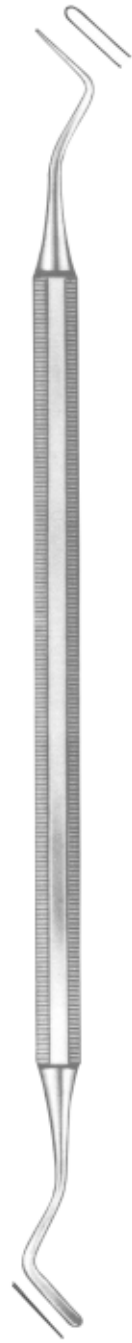

VI-2174  
Fig 158

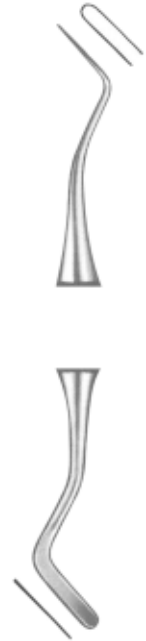

VI-2175  
Fig 159

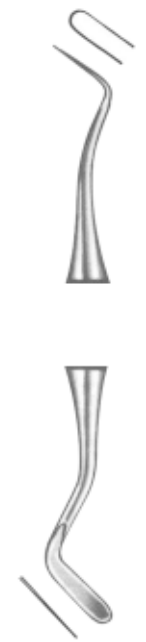

VI-2176  
Woodson  
Fig 160



**VI-2177**  
Gracey



**VI-2178**  
Gracey  
Fig 1



**VI-2179**  
Gracey  
Fig 2



**VI-2180**  
Gracey  
Fig 3



**VI-2181**  
Gracey  
Fig 4



**VI-2182**  
Gracey  
Fig 5

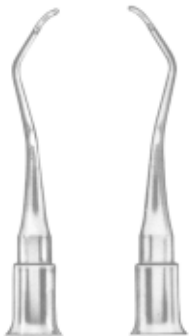

**VI-2183**  
Gracey  
Fig 6



**VI-2184**



**VI-2185-1**  
Fig 18



**VI-2186-2**  
Fig 19



**VI-2187-3**  
Fig 20



**VI-2188-4**  
Fig 22



**VI-2190-5**  
Fig 23



**VI-2191-6**  
Fig 25



**VI-2192-7**  
Fig 26



**VI-2193-8**  
Fig 27

Dental Probes

With Point Set In



VI-2194



VI-2195-1



VI-2196-2



VI-2197-3



VI-2198-4



VI-2199-5



VI-2200-6



VI-2201-7



VI-2202-8



VI-2203-9



VI-2204-10



VI-2205-11



VI-2206-2  
Woodson

Polishing Instruments

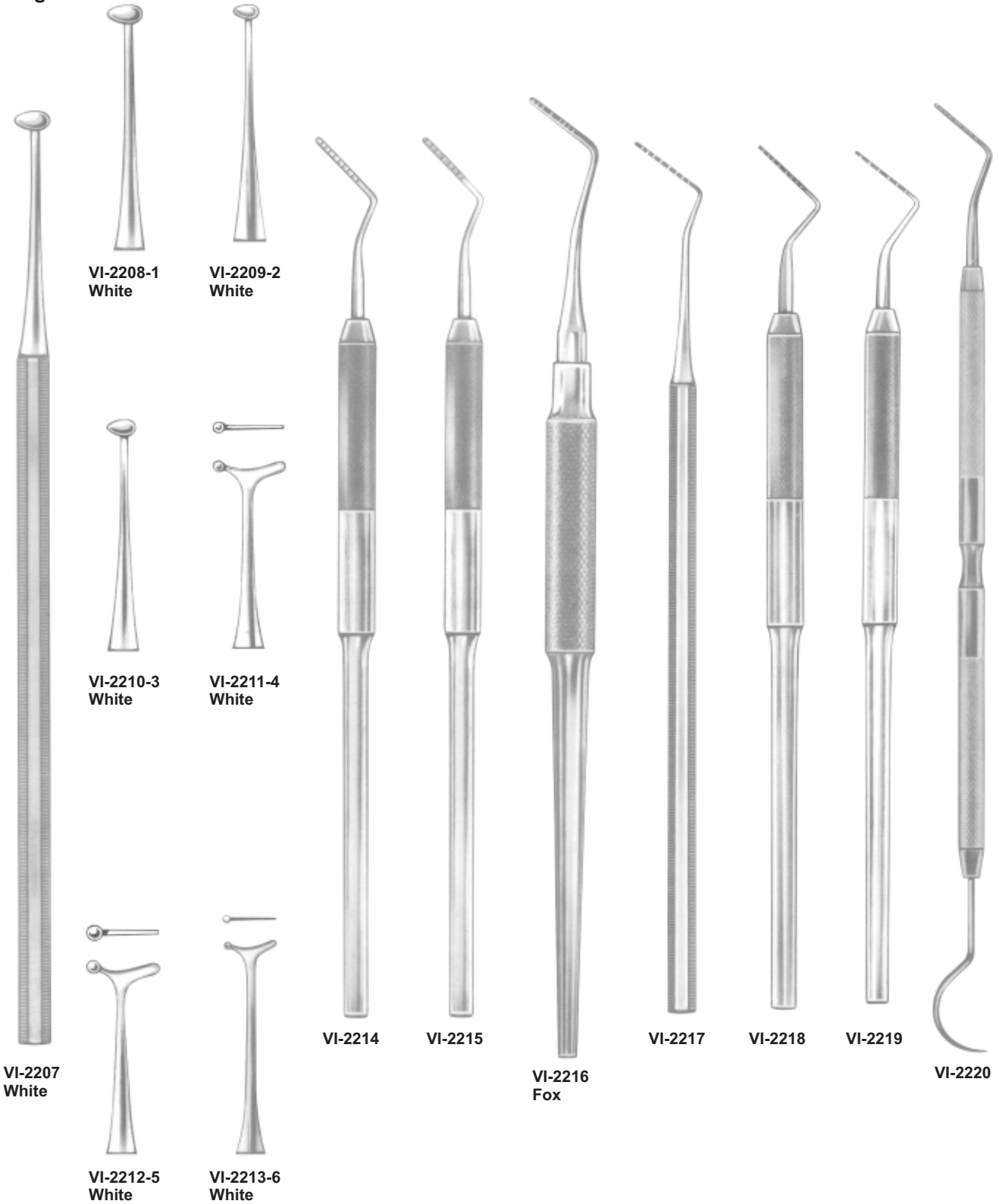



- New marking process.
- Laser system marking.
- No more paint peeling off.
- Permanent marking.
- Antiglare, low depth marking.
- Maximum tip resistance against breaking.



**VI-2221**  
Fig CP-C



**VI-2222**  
Fig CP-11



**VI-2223**  
Fig CP-12



**VI-2224**  
Fig CP-12S  
O.M.S

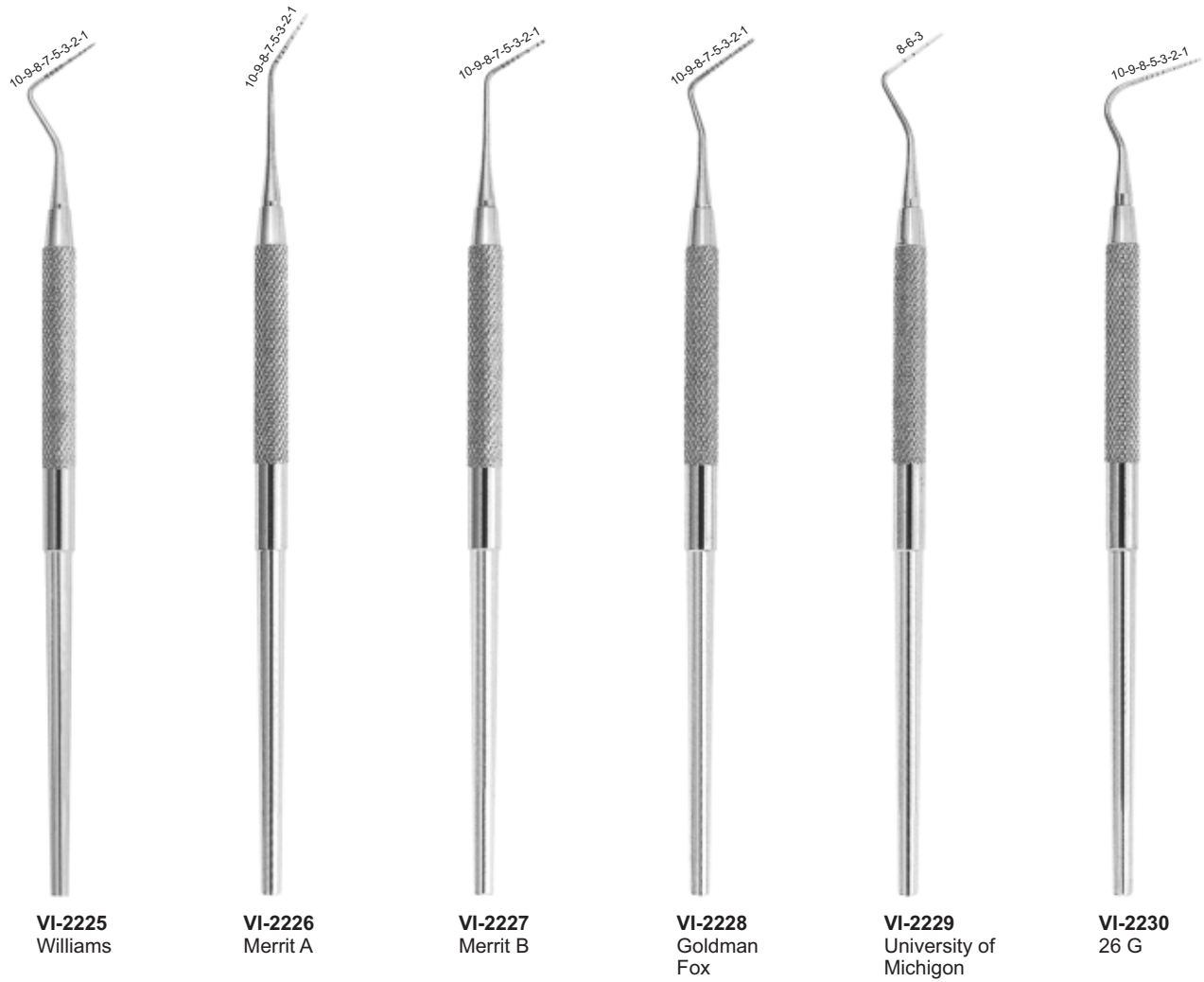



**VAKMAN**  
INDUSTRIES

**03**

# Page 61-75

- Periodontia Instruments,
- Mallets, Curettes & Scalers





Files

Chisels



**VI-3001**  
Sugarman  
Fig. 1S/2S



**VI-3002**  
Sugarman  
Fig. 3S/4S



**VI-3003**  
Schluger  
Fig. 9/10



**VI-3004**  
Buck  
Fig. 11/12



**VI-3005**  
Ochsenbein  
Fig. 3



**VI-3006**  
Ochsenbein  
Fig. 4



**VI-3007**  
Rhodes  
Back - Action  
Fig. 36/37

Files

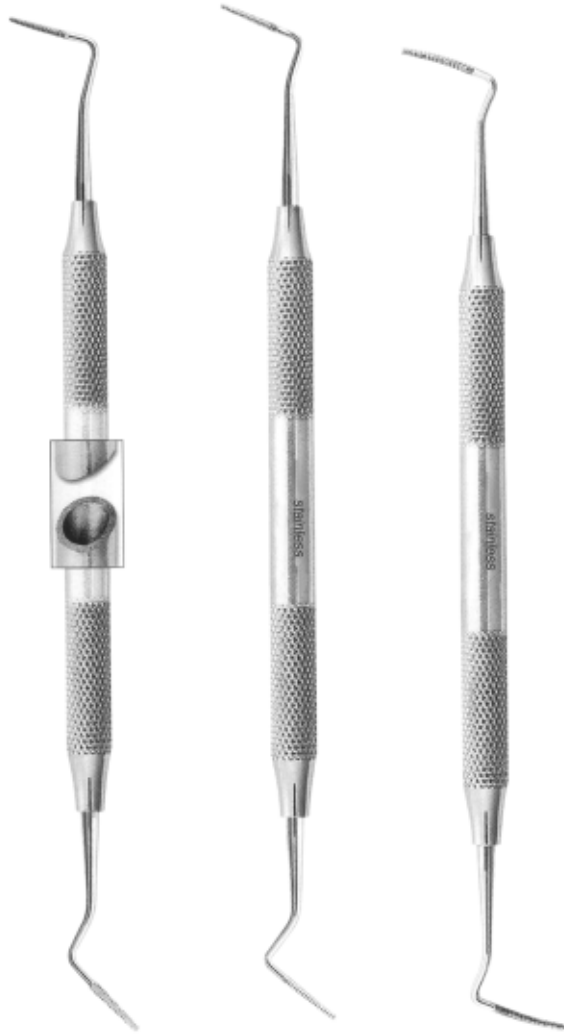

VI-3008  
Sugarman  
Fig. 1S/2S

VI-3009  
Sugarman  
Fig. 3S/4S

VI-3010  
Schluger  
Fig. 9/10



VI-3011  
Buck  
Fig. 11/12

Chisels



VI-3012  
Ochsenbein  
Fig. 3



VI-3013  
Ochsenbein  
Fig. 4



VI-3014  
Rhodes  
Back - Action  
Fig. 36/37

Gingivectomy knives



**VI-3015**  
Goldman-Fox  
Fig. 7



**VI-3016**  
Goldman-Fox  
Fig. 8



**VI-3017**  
Goldman-Fox  
Fig. 9



**VI-3018**  
Goldman-Fox  
Fig. 11



**VI-3019**  
Buck  
Fig. 3/4



**VI-3020**  
Buck  
Fig. 5/6

Curettes and Scalers



**VI-3021**  
Curette  
Fig. HU 1/2



**VI-3022**  
Columbia  
Fig. 2R/2L



**VI-3023**  
Columbia  
Fig. 4R/4L



**VI-3024**  
Columbia  
Fig. 13/14



**VI-3025**  
Fig. 411/412



**VI-3026**  
Fig. 413/414



**VI-3027**  
Zerfing-chisel



Gingivectomy knives



**VI-3028**  
Goldman - Fox  
Fig. 7



**VI-3029**  
Goldman - Fox  
Fig. 8



**VI-3030**  
Goldman - Fox  
Fig. 9



**VI-3031**  
Goldman - Fox  
Fig. 11



**VI-3032**  
Buck  
Fig. 3/4



**VI-3033**  
Buck  
Fig. 5/6

Curettes and Scalers



**VI-3034**  
Curette  
Fig. HU 1/2



**VI-3035**  
Columbia  
Fig. 2R/2L



**VI-3036**  
Columbia  
Fig. 4R/4L



**VI-3037**  
Columbia  
Fig. 13/14



**VI-3038**  
Fig. 413/412



**VI-3039**  
Fig. 411/414



**VI-3040**  
Zerfing-chisel

### Bone Chisels and Gouges

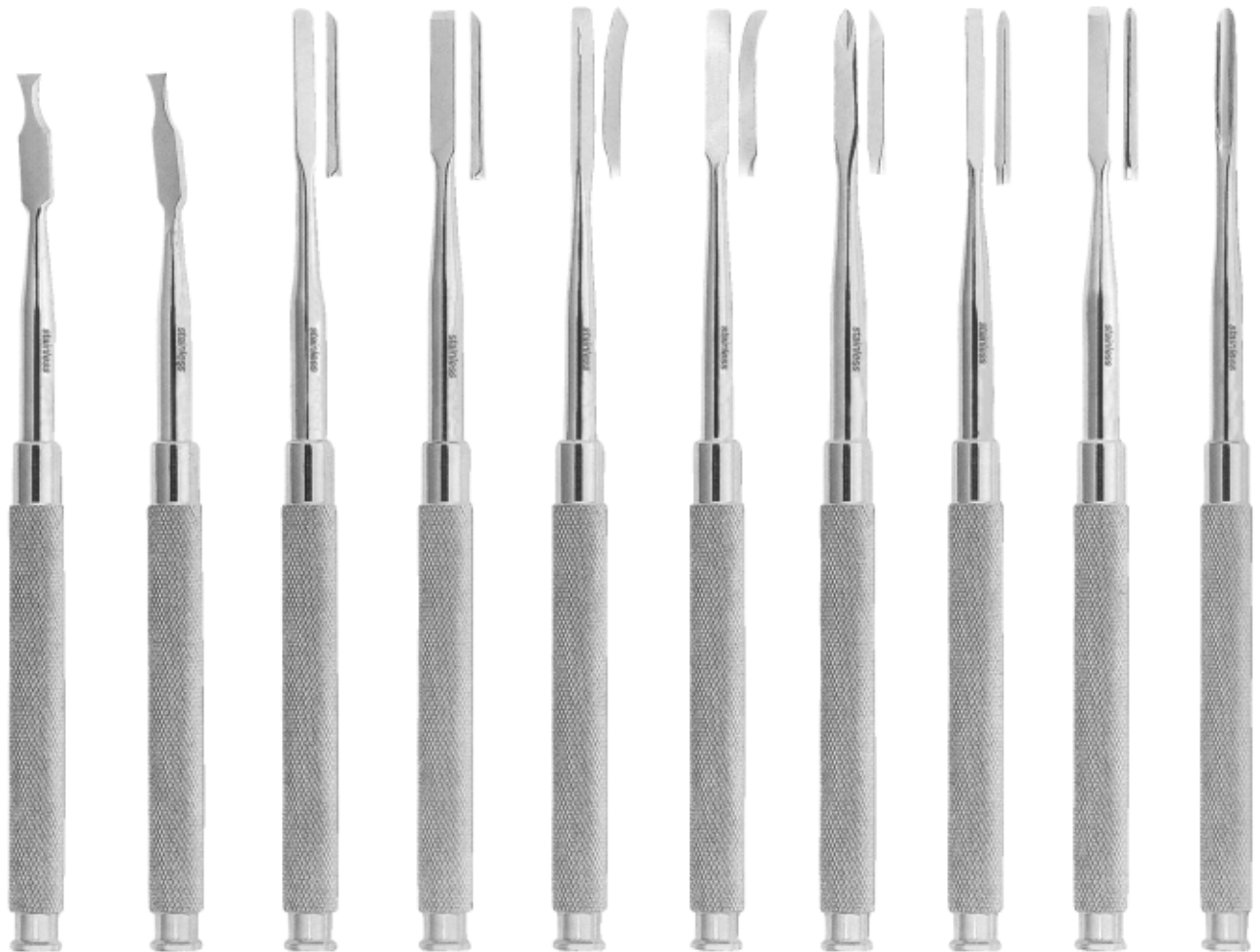

**VI-3041**  
Ochsenbein  
Fig. 1

**VI-3042**  
Ochsenbein  
Fig. 2

**VI-3043**  
Gardner  
Fig. 1

**VI-3044**  
Gardner  
Fig. 2

**VI-3045**  
Gardner  
Fig. 5

**VI-3046**  
Gardner  
Fig. 5R

**VI-3047**  
Gardner  
Fig. 6

**VI-3048**  
Wakefield  
Fig. 1W

**VI-3049**  
Wakefield  
Fig. 2W

**VI-3050**  
Buckley  
Fig. 3

**Bone Chisels and Gouges**

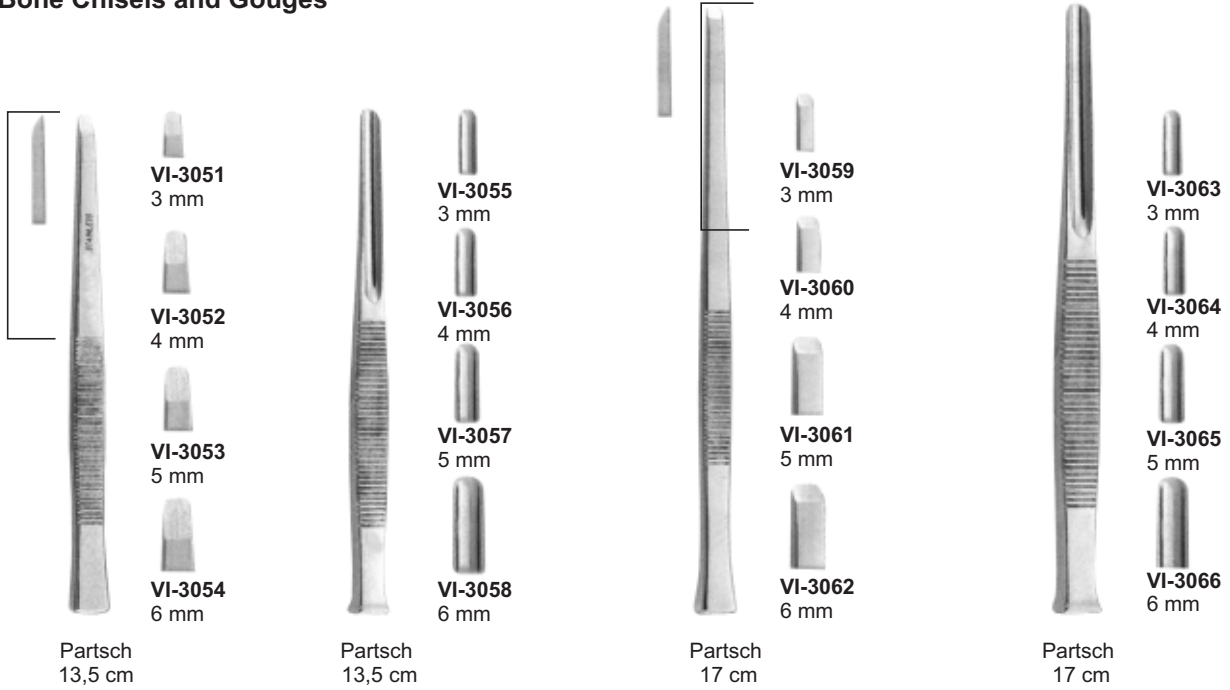

Martelli chirurgici  
Mallet

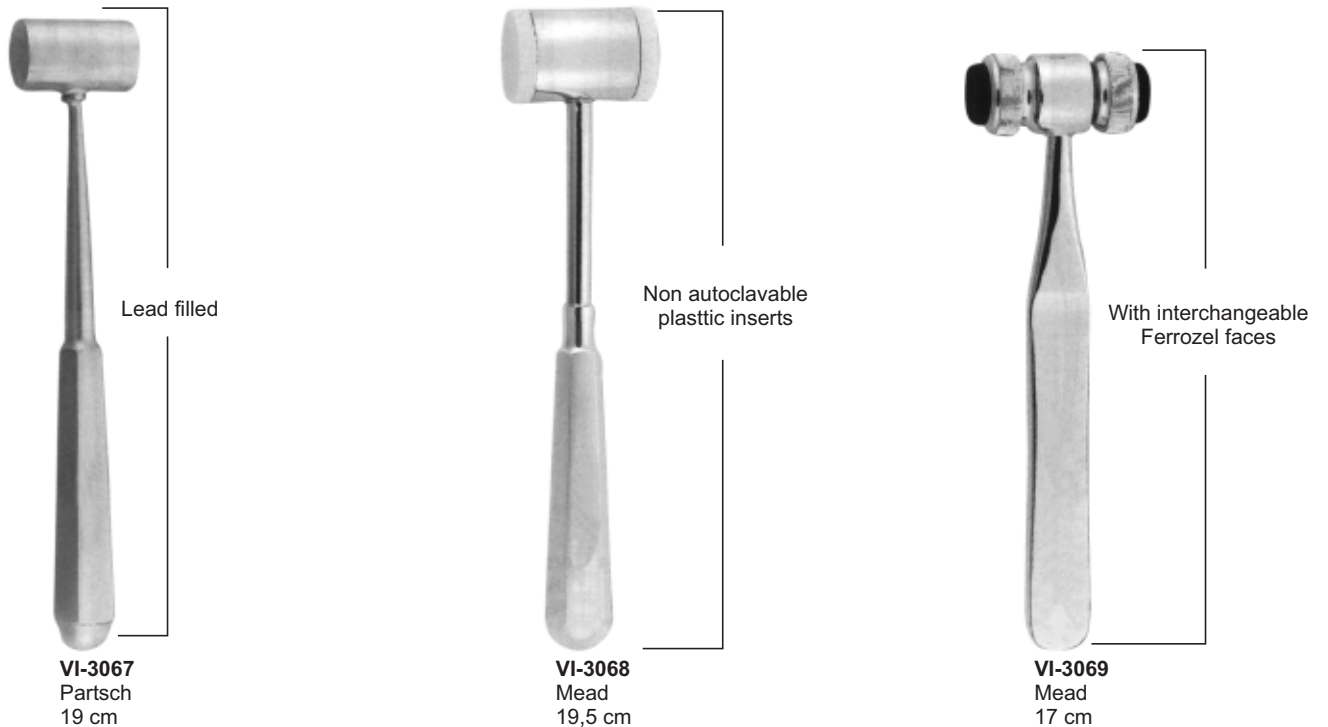



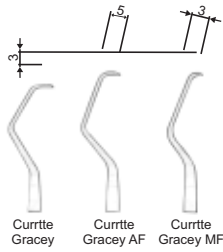

**VI-3070**  
Gracey  
Fig. 1/2



**VI-3071**  
Gracey  
Fig. 3/4



**VI-3072**  
Gracey  
Fig. 5/6



**VI-3073**  
Gracey  
Fig. 7/8



**VI-3074**  
Gracey  
Fig. 9/10



**VI-3075**  
Gracey  
Fig. 11/12



**VI-3076**  
Gracey  
Fig. 13/14



**VI-3077**  
Gracey  
Mesial Distal  
Fig. 11/14



**VI-3078**  
Gracey  
Mesial Distal  
Fig. 12/13

Gracey Currettes AF Type

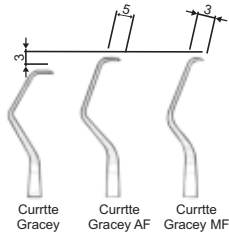

**VI-3079**  
Gracey  
AF/type  
Fig. 1/2



**VI-3080**  
Gracey  
AF/type  
Fig. 3/4



**VI-3081**  
Gracey  
AF/type  
Fig. 5/6



**VI-3082**  
Gracey  
AF/type  
Fig. 7/8



**VI-3083**  
Gracey  
AF/type  
Fig. 11/12



**VI-3084**  
Gracey  
AF/type  
Fig. 13/14



**VI-3085**  
Gracey  
AF/type  
Fig. 15/16



**VI-3087**  
Gracey  
AF/type  
Fig. 1/2



**VI-3088**  
Gracey  
AF/type  
Fig. 3/4



**VI-3089**  
Gracey  
AF/type  
Fig. 5/6



**VI-3090**  
Gracey  
AF/type  
Fig. 7/8



**VI-3091**  
Gracey  
AF/type  
Fig. 11/12



**VI-3092**  
Gracey  
AF/type  
Fig. 13/14



**VI-3093**  
Gracey  
AF/type  
Fig. 15/16



**VI-3094**  
Gracey  
MF/type  
Fig. 1/2



**VI-3095**  
Gracey  
MF/type  
Fig. 3/4



**VI-3096**  
Gracey  
MF/type  
Fig. 5/6



**VI-3097**  
Gracey  
MF/type  
Fig. 7/8



**VI-3098**  
Gracey  
MF/type  
Fig. 11/12



**VI-3099**  
Gracey  
MF/type  
Fig. 13/14



**VI-3100**  
Gracey  
MF/type  
Fig. 15/16

**VI-3086**  
Gracey  
AF/type

Gracey Curettes AF Type

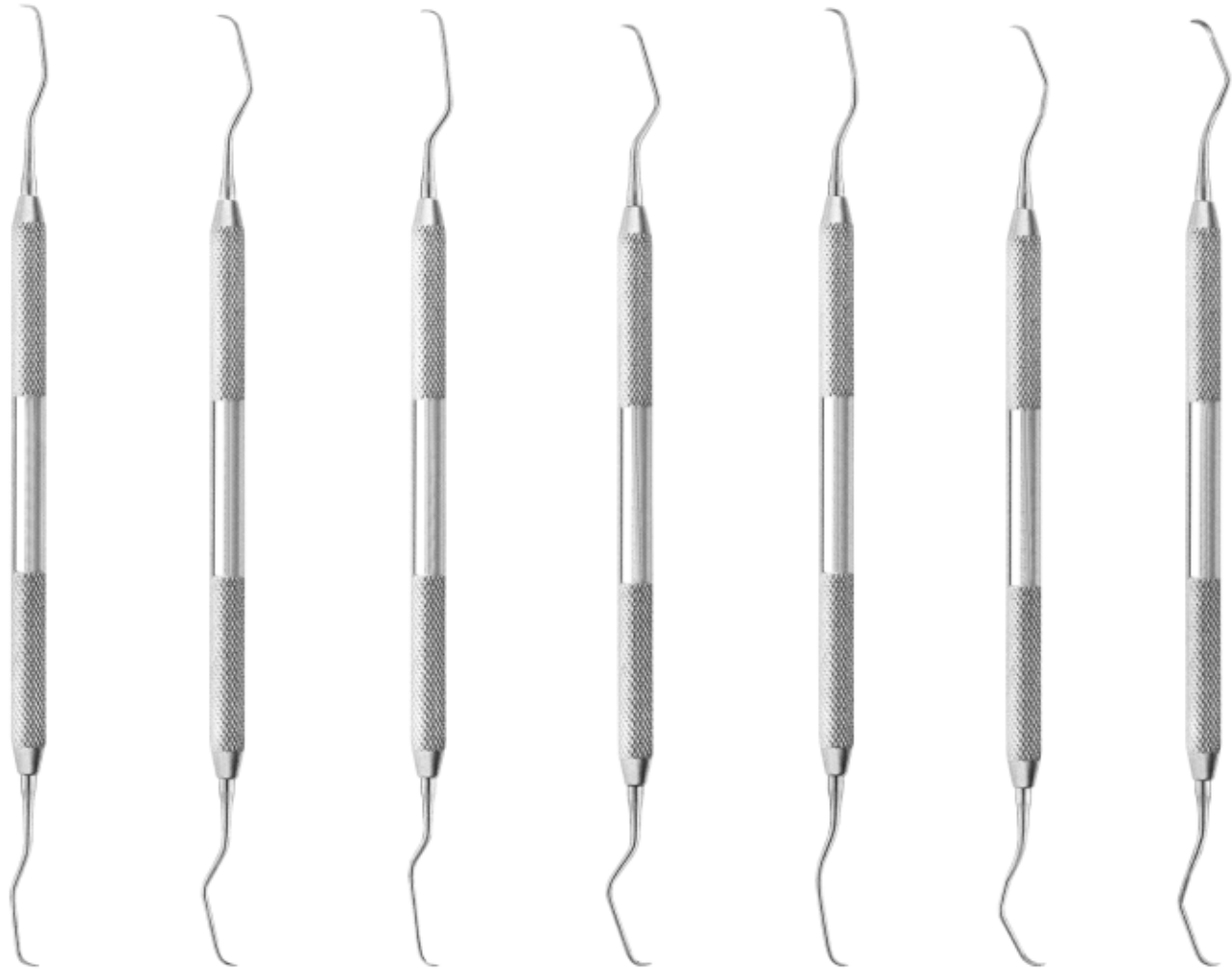
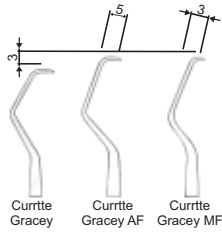

**VI-3101**  
Gracey  
MF/type  
Fig. 1/2

**VI-3102**  
Gracey  
MF/type  
Fig. 3/4

**VI-3103**  
Gracey  
MF/type  
Fig. 5/6

**VI-3104**  
Gracey  
MF/type  
Fig. 7/8

**VI-3105**  
Gracey  
MF/type  
Fig. 11/12

**VI-3106**  
Gracey  
MF/type  
Fig. 13/14

**VI-3107**  
Gracey  
MF/type  
Fig. 15/16



**VI-3108**  
Goldman - Fax  
Fig. 1



**VI-3109**  
Goldman - Fax  
Fig. 2



**VI-3110**  
Goldman - Fax  
Fig. 3



**VI-3111**  
Goldman - Fax  
Fig. 4



**VI-3112**  
Goldman - Fax  
Fig. 21

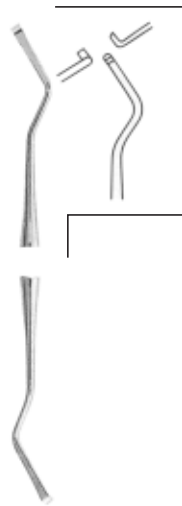

**VI-3113**  
Goldman - Fax  
Fig. 5



**VI-3114**  
Mc Call  
Fig. 13S/14S

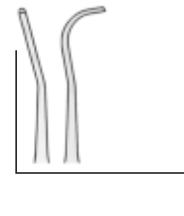

**VI-3115**  
Younger-Good  
Fig. 7/8

Curettes and Scalers

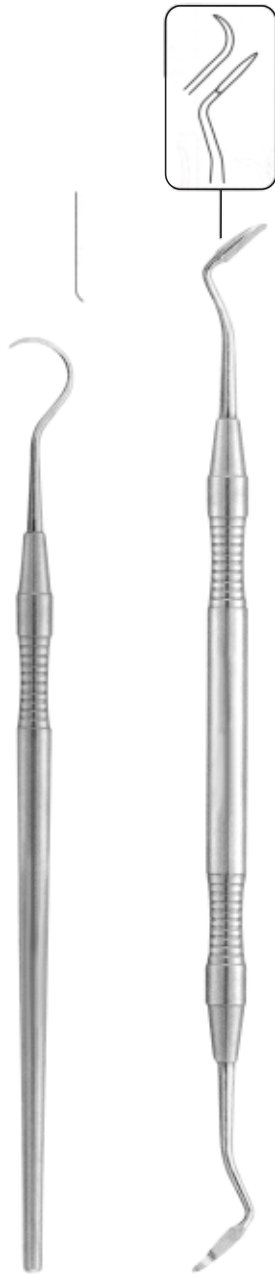

VI-3116  
Towner  
Fig. U15

VI-3117  
Crane - Kaplan  
Fig. 6



VI-3118  
Crane - Kaplan  
Fig. 6S



VI-3119  
Taylor  
Fig. 2/3



VI-3120  
Fig. 204S



VI-3121  
Towner Jaquette  
Fig. U15/33

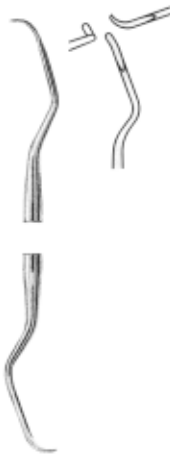

VI-3122  
Columbia  
Fig. 2R/2L



VI-3123  
Columbia  
Fig. 4R/4L



VI-3124  
Columbia  
Fig. 13/14



VI-3125  
Jaquette  
Fig. 1



VI-3126  
Jaquette  
Fig. 2



VI-3127  
Jaquette  
Fig. 3



**VI-3128**  
Hemingway  
Fig. 1



**VI-3129**  
Hemingway  
Fig. 2



**VI-3130**  
Hemingway  
Fig. 3



**VI-3131**  
Lucas  
Fig. 85



**VI-3132**  
Lucas  
Fig. 86



**VI-3133**  
Lucas  
Fig. 87



**VAKMAN**  
INDUSTRIES

04

## Page 76-88

- Modelling Instruments, Wax Knives/plaster
- Diagnostic, Explorer, Endodontic
- Instruments & Excavators



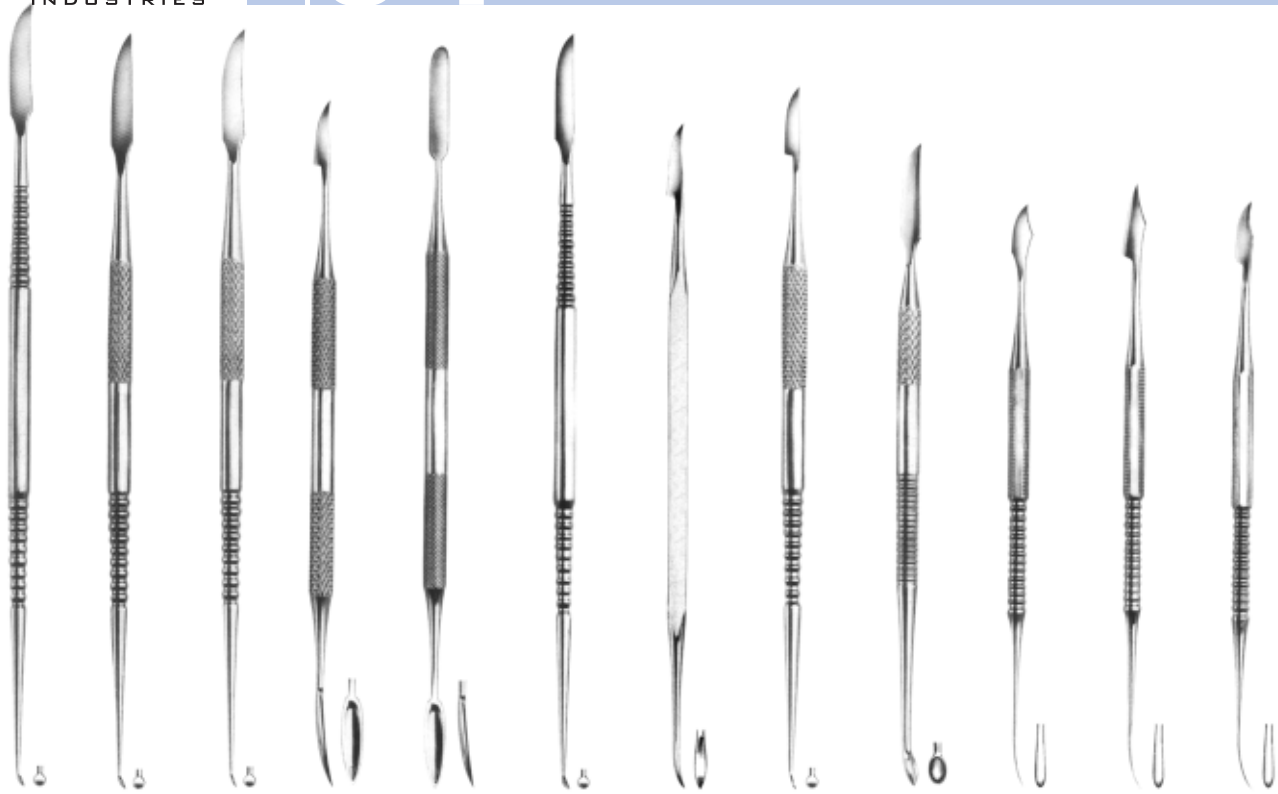

VI-4000 Le Cron   VI-4001 Le Cron   VI-4002 Le Cron   VI-4003 MSY   VI-4004 MSY   VI-4005 Le Cron   VI-4006 Hylin   VI-4007 Hylin   VI-4008 Hylin   VI-4009 Zahle   VI-4010 Zahle   VI-4011 Zahle

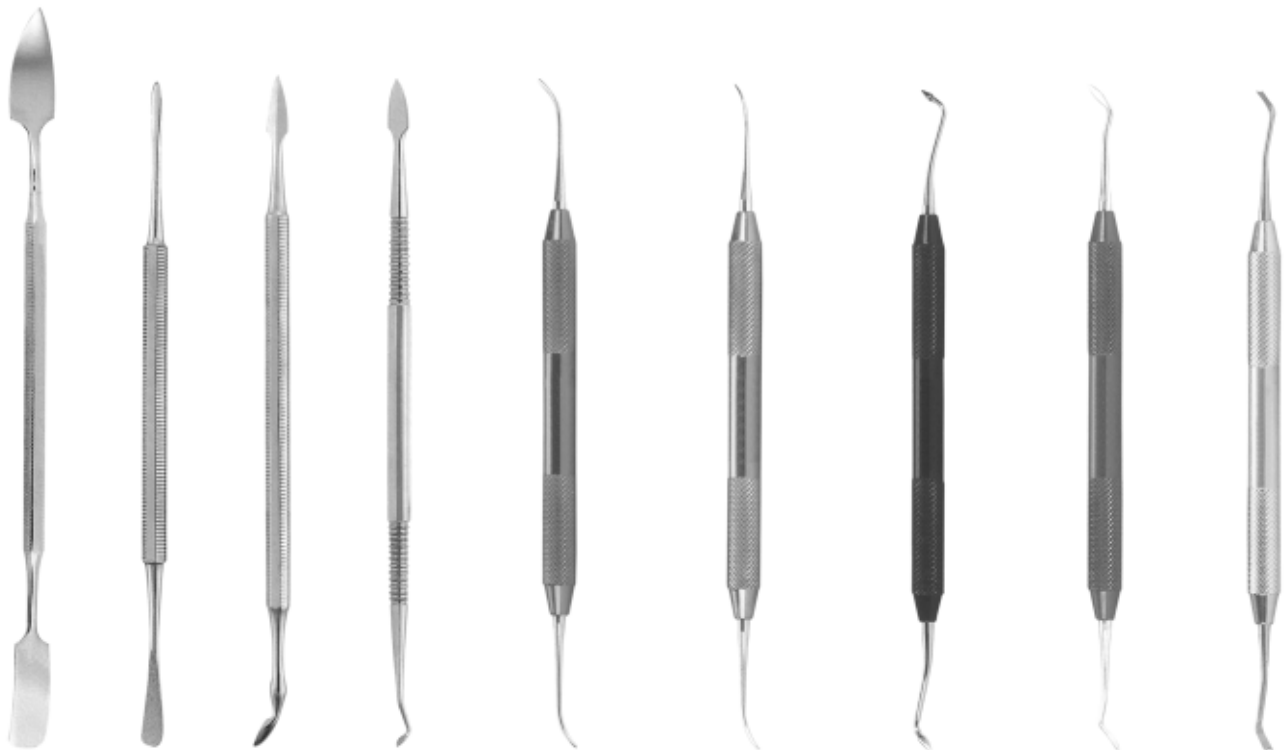

VI-4012 Gritman   VI-4013 Beale   VI-4014 Roach   VI-4015 Vehe   VI-4016 P.K. Thomas Fig, 1   VI-4017 P.K. Thomas Fig, 2   VI-4018 P.K. Thomas Fig, 3   VI-4019 P.K. Thomas Fig, 4   VI-4020 P.K. Thomas Fig, 5

Measuring Instruments



**VI-4021**  
Boley



**VI-4022**  
Zuricher  
130 mm



**VI-4023**  
Vernier  
12 cm



**VI-4024**  
Vernier

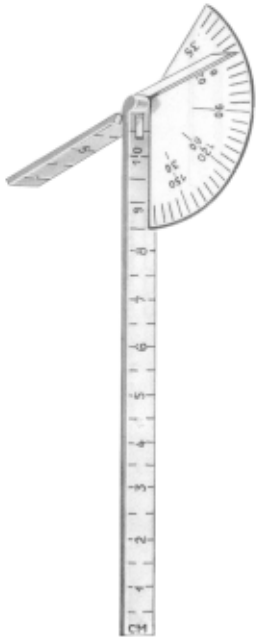

**VI-4025**  
Caroll



**VI-4026**  
Castroviejo's  
Scleral Marker



**VI-4027**  
Iwanson



**VI-4028**  
Albee



**VI-4029**  
18 cm  
7 1/8"



**VI-4030**  
18 cm  
7 1/8"



**VI-4031**  
17 cm  
6 3/4"  
Gritman



**VI-4032**  
17 cm  
6 3/4"  
Medicon



**VI-4033**  
22 cm  
8 3/4"



**VI-4034**  
Antkoviak



**VI-4035**  
Ermert



**VI-4036**  
Ermert

## Wax Knives



**VI-4037**  
Fahnenstock  
Fig. 1  
12,5cm



**VI-4038**  
Fahnenstock  
Fig. 2  
17cm



**VI-4039**  
Lessmann  
Fig. 1  
12,5cm



**VI-4040**  
Lessmann  
Fig. 2  
17cm



**VI-4041**  
Con scodellino  
Fig. 1  
12,5cm



**VI-4042**  
Con scodellino  
Fig. 2  
17cm



**VI-4043**  
Fig. 1  
17 cm



**VI-4044**  
Gritman  
Fig. 2  
17 cm



**VI-4045**  
Fig. 3  
16 cm



**VI-4046**  
Fig. 4  
16 cm

Explorers



VI-4047  
Fig 23



VI-4048  
Fig 6



VI-4049  
Fig 8



VI-4050  
Fig 9



VI-4051  
Fig 17



VI-4052  
Fig 3  
Rein



VI-4053  
Fig 23/17



VI-4054  
Fig 17

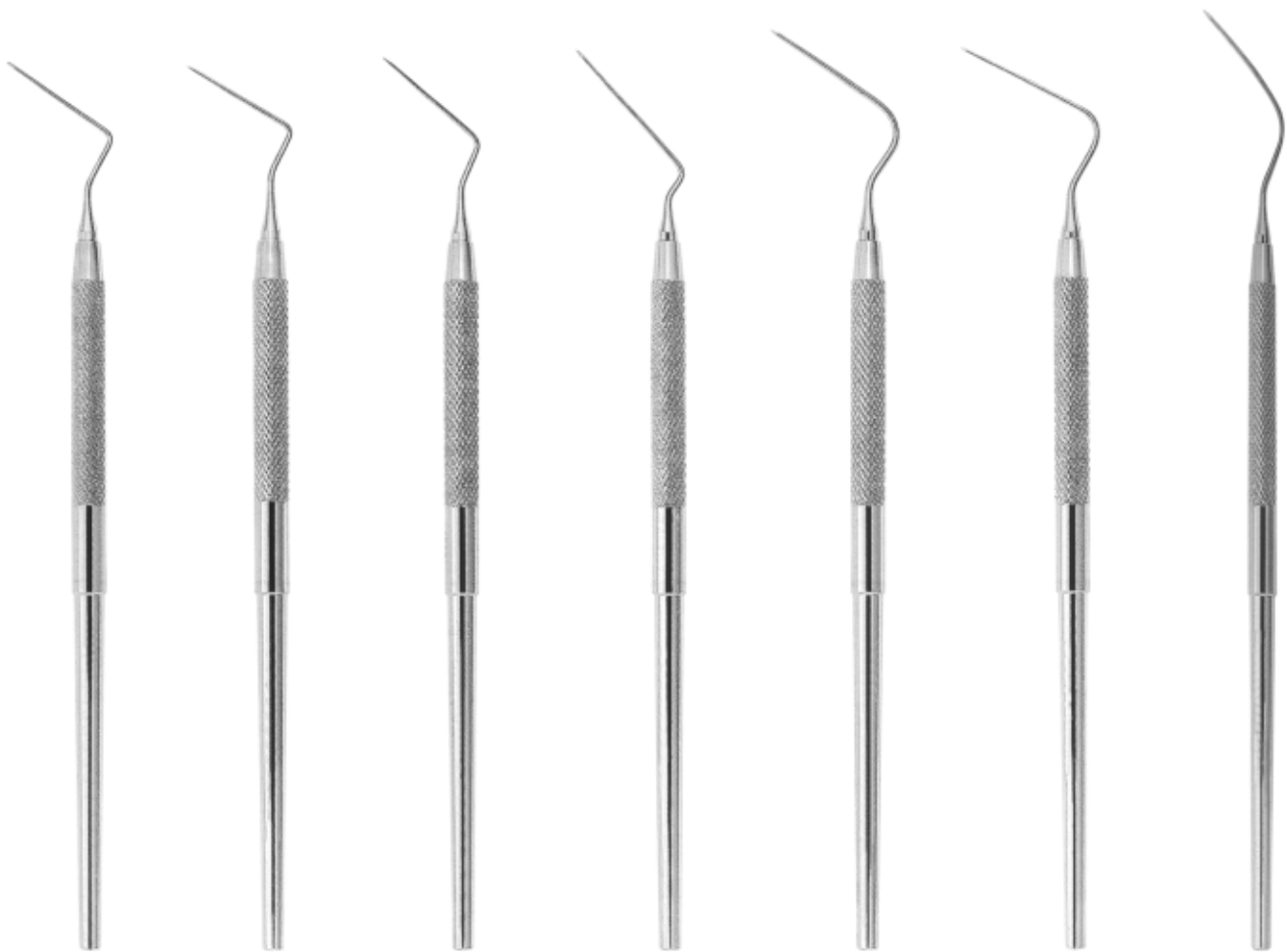

**VI-4055**  
Fig.1  
Spreader

**VI-4056**  
Fig.2  
Spreader

**VI-4057**  
Fig.3  
Spreader

**VI-4058**  
Fig.4  
Spreader

**VI-4059**  
Fig.5  
Spreader

**VI-4060**  
Fig.6  
Spreader

**VI-4061**  
Fig.7  
Spreader

Endodontic Instruments

Double-Ended Root Canal Explorers Plugger/Spreaders

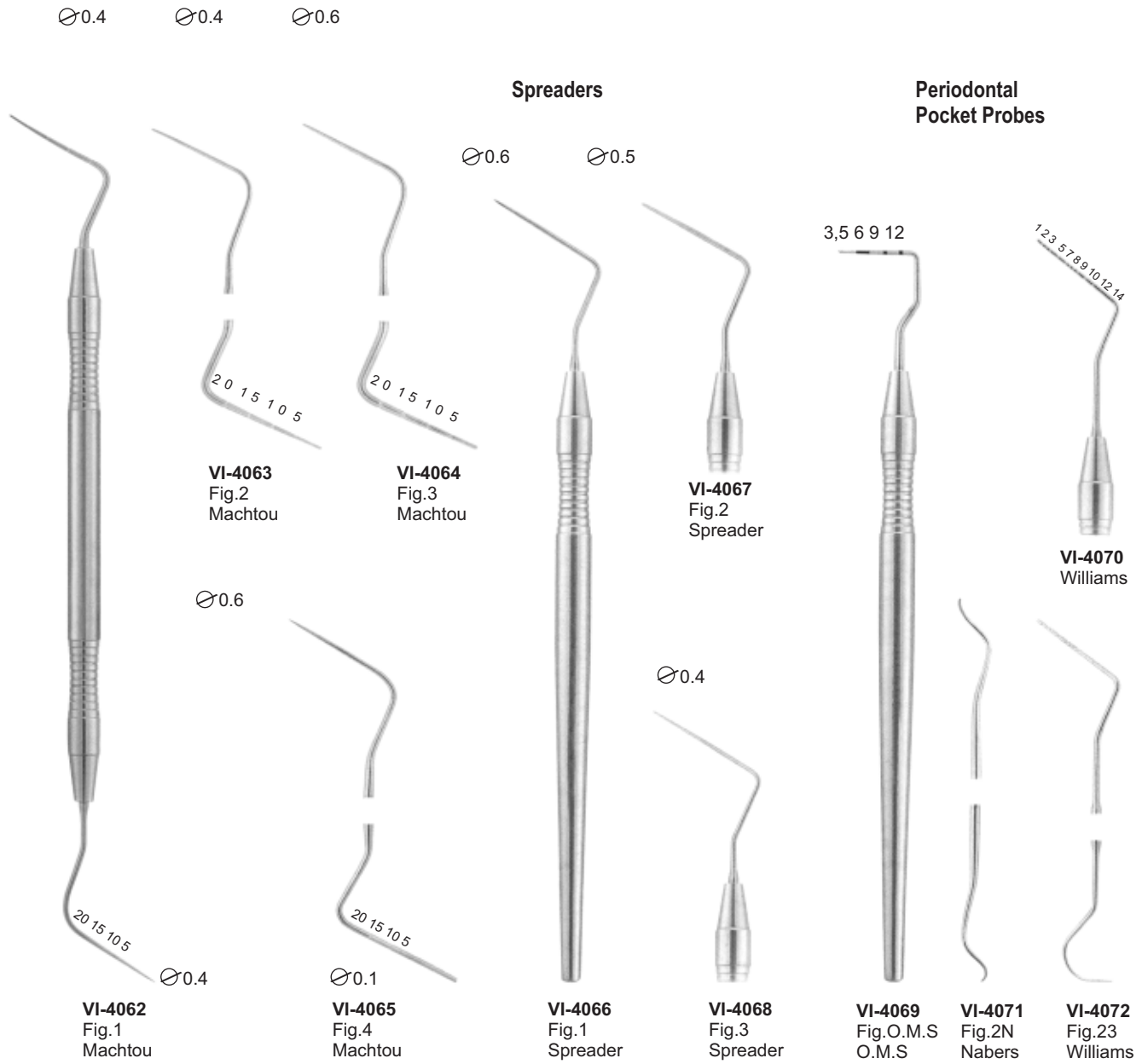





Root-canal pluggers

Ø0.5



**VI-4073**  
Fig.1  
Luks

Ø0.7



**VI-4074**  
Fig.2  
Luks

Ø0.9



**VI-4075**  
Fig.3  
Luks

Ø1.1



**VI-4076**  
Fig.4  
Luks

Ø0.5



**VI-4077**  
Fig.1  
Vertical  
condenser

Ø0.7



**VI-4078**  
Fig.2  
Vertical  
condenser

Ø0.9



**VI-4079**  
Fig.3  
Vertical  
condenser

Ø1.1



**VI-4080**  
Fig.4  
Vertical  
condenser

Endodontic set



**VI-4081**  
Measuring Plate

Endodontic Instruments

Root-canal pluggers

Optimum Flexibility  
Very Fine Points

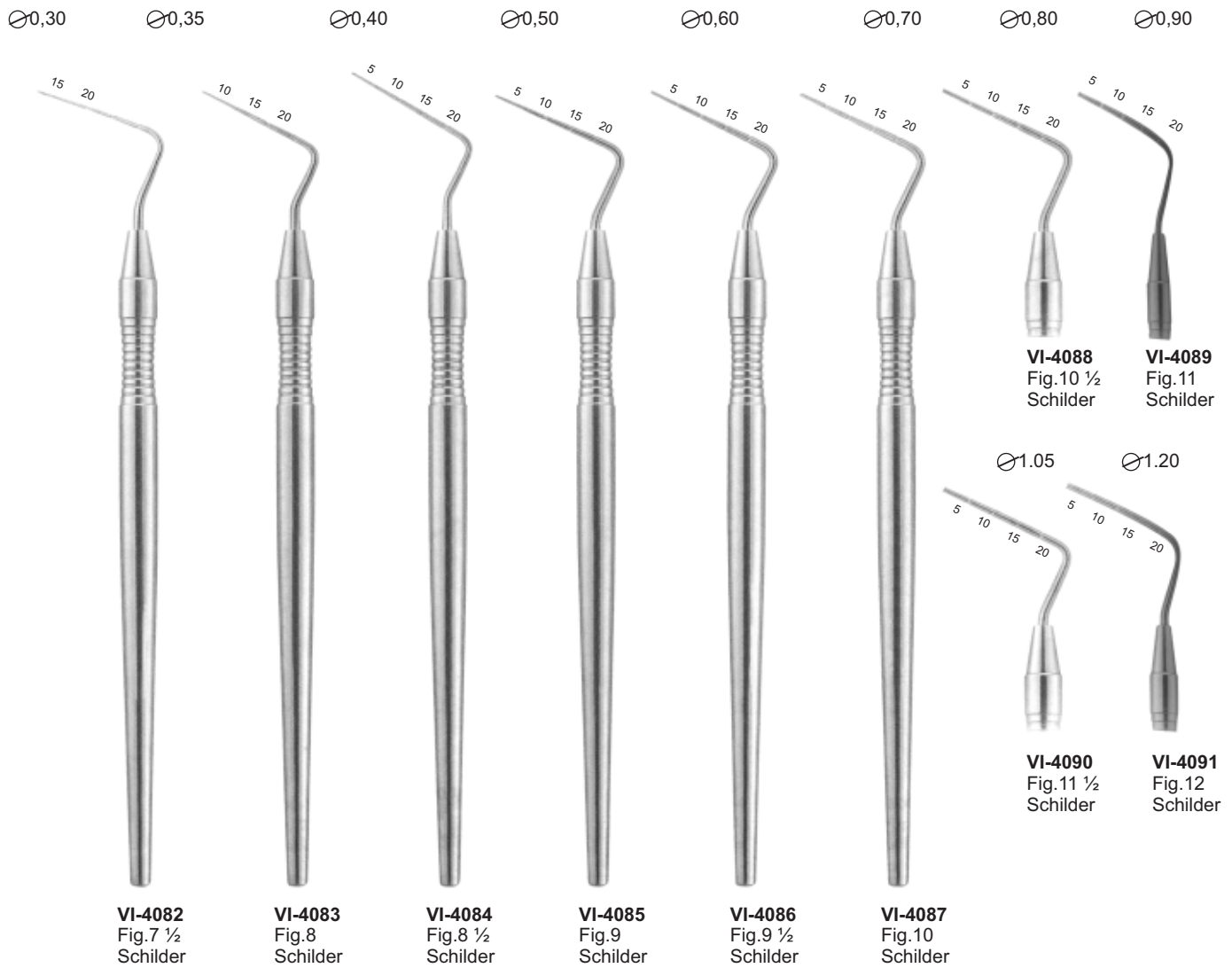

Root-canal explorers

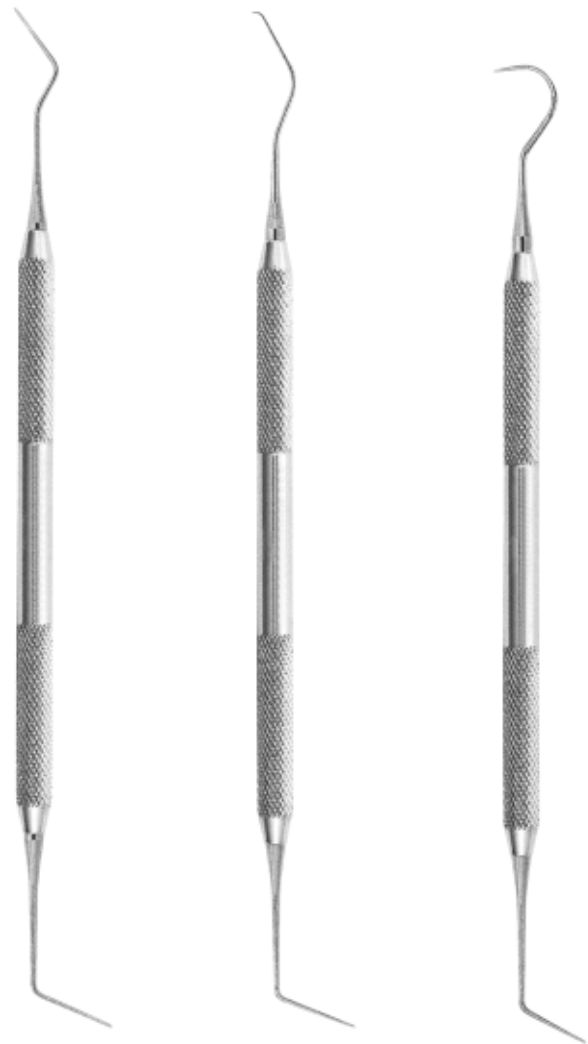

VI-4092  
Fig.6/1

VI-4093  
Fig.6/17

VI-4094  
Fig.6/23

Root-canal excavators



VI-4095  
Fig.31L

VI-4096  
Fig.32L

VI-4097  
Fig.33L

Excavators

1 mm



**VI-4098**  
Fig 5

1.2 mm



**VI-4099**  
Fig 14

1 mm



**VI-4100**  
Fig 17

1.2 mm



**VI-4101**  
Fig 18

1.6 mm



**VI-4102**  
Fig 19

2 mm



**VI-4103**  
Fig 20

1 mm



**VI-4104**  
ASH  
Fig.243

1,4 mm



**VI-4105**  
ASH  
Fig.G2

0,8 mm



**VI-4106**  
Fig.1

0,8 mm



**VI-4107**  
Fig.2

1 mm



**VI-4108**  
Fig.11

1 mm



**VI-4109**  
Fig.12

1,2 mm



**VI-4110**  
Fig.21

1,2 mm



**VI-4111**  
Fig.22

1,6 mm



**VI-4112**  
Fig.31

1,6 mm



**VI-4113**  
Fig.32

2 mm



**VI-4114**  
Fig.41

2 mm



**VI-4115**  
Fig.42



**VAKMAN**  
INDUSTRIES

**05**

## Page 89-118

- Handles For Mouth Mirrors, Spatulas,
- Needle Holders, syringes, Dental Tweezers,
- Rubber Dam & Clamps

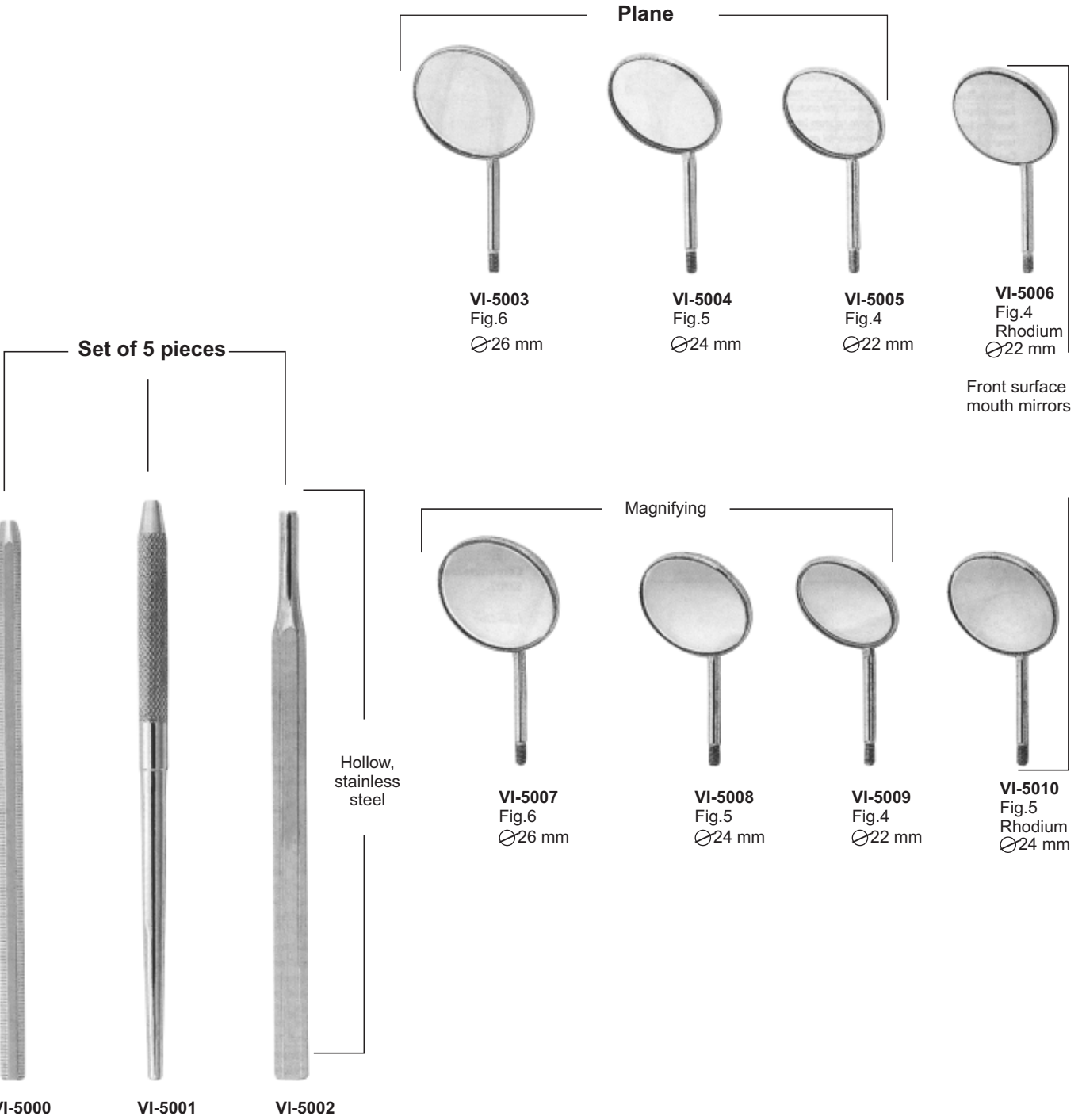

Handles for Mouth Mirrors and Mouth Mirrors



VI-5011



VI-5012



VI-5013



VI-5014



VI-5015



VI-5016  
Parallelometer  
mouth mirror

VI-5017  
Parallelometer  
mouth mirror  
+ handle  
code 2101

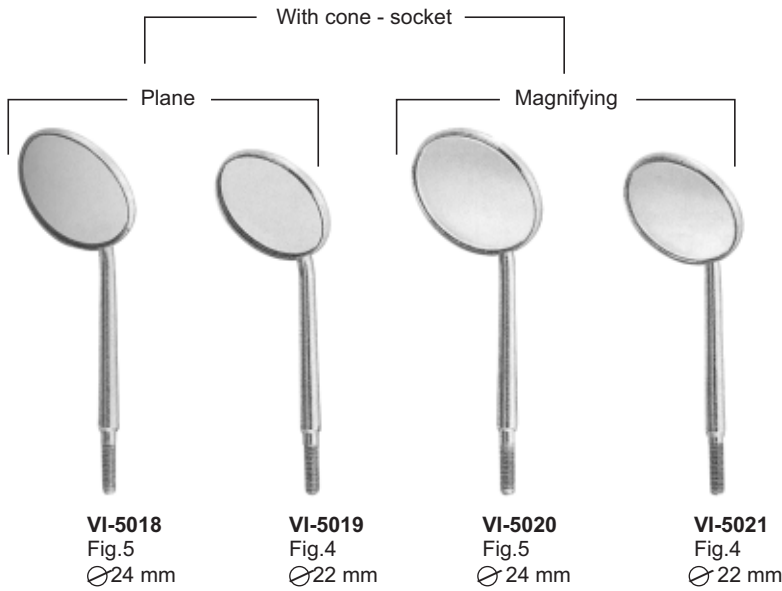

VI-5022  
Cone - socket



VI-5023  
Cone - socket



VI-5024  
Cone - socket





VI-5025



VI-5026



VI-5027



VI-5028

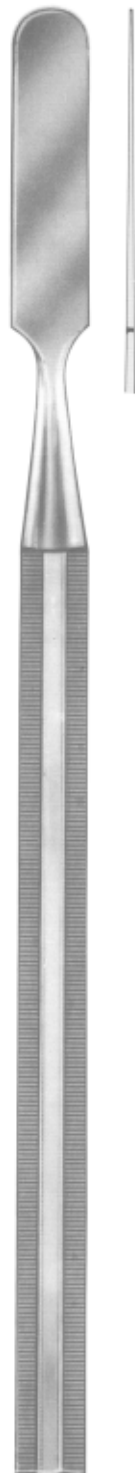

VI-5029



VI-5030



VI-5031



VI-5032

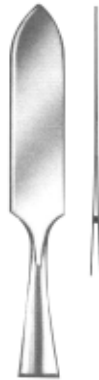
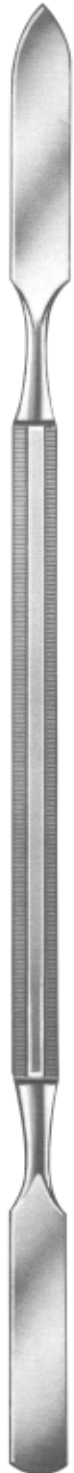
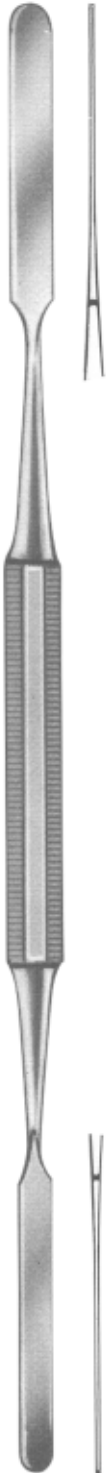







**VI-5049**  
Mayo-Hegar  
16 cm



**VI-5050**  
Mayo-Hegar TC  
16 cm



**VI-5051**  
Mayo-Hegar  
18 cm



**VI-5052**  
Mayo-Hegar TC  
18 cm



**VI-5053**  
Mini-Ryder  
18 cm



**VI-5054**  
Mini-Ryder  
15 cm



**VI-5055**  
Derf  
12 cm



**VI-5056**  
Hegar-Baumgarther  
14 cm



**VI-5057**  
Crile-Wood  
15 cm



**VI-5058**  
Crile-Wood TC  
15 cm



**VI-5059**  
Adson  
17.5 cm



**VI-5060**  
Olsen-Hegar  
14 cm



**VI-5061**  
Baumgarther  
14.5 cm



**VI-5062**  
Gillies  
16 cm



**VI-5063**  
Gillies  
16 cm



**VI-5064**  
Hegar-Baumgarther  
14 cm



**VI-5065**  
Toennis  
18 cm



**VI-5066**  
Toennis  
18 cm



**VI-5067**  
Lichtenberg  
17 cm



**VI-5068**  
Lichtenberg  
17 cm



**VI-5069**  
Eiselberg-Mathieu  
19.5 cm



**VI-5070**  
Boynton  
12 cm



**VI-5071**  
Arruga  
16 cm



**VI-5072**  
Boynton  
12 cm



**VI-5073**  
Arruga  
16 cm

Needle Holders



**VI-5074**  
Castroviejo  
14 cm



**VI-5075**  
Castroviejo  
14 cm



**VI-5076**  
Castroviejo  
14/60 cm



**VI-5077**  
Castroviejo  
18 cm



**VI-5078**  
Castroviejo  
18 cm



**VI-5079**  
Castroviejo  
14 cm



**VI-5080**  
Castroviejo  
14 cm



**VI-5081**  
Castroviejo  
14/60 cm



**VI-5082**  
Castroviejo  
18 cm



**VI-5083**  
Castroviejo  
18 cm





**VI-5084**  
Mathieu  
14 cm



**VI-5085**  
Mathieu  
14 cm



**VI-5086**  
Mathieu  
14 cm



**VI-5087**  
Mathieu  
14 cm



**VI-5088**  
Mathieu  
17 cm



**VI-5089**  
Mathieu  
17 cm



**VI-5090**  
Mathieu  
14 cm



**VI-5091**  
Micro-Barraquer  
18 cm

Needle Holders & Stainless Steel Saliva Ejectors



The tips have tungsten carbide inserts for better handling.



**VI-5092**  
Mathieu  
17 cm



**VI-5093**  
Mathieu  
17 cm



**VI-5094**  
Micro-Barraquer  
14 cm



**VI-5095**  
Castroviejo  
13 cm



**VI-5096**  
Castroviejo-Barraquer  
13 cm



**VI-5097**  
Castrpviejo  
13 cm



**VI-5098**  
Castrpviejo  
13 cm



**VI-5100**  
18.03mm,cm



**VI-5101**  
18.04mm,cm



**VI-5102**  
18.05mm,cm



**VI-5103**  
Fig. 12FR  
Fraizer  
15.04mm,cm



**VI-5104**  
Fig. 10FR  
Fraizer  
15.03,3mm,cm

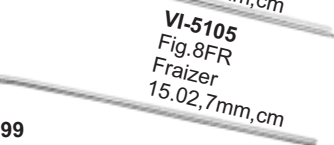

**VI-5105**  
Fig. 8FR  
Fraizer  
15.02,7mm,cm



**VI-5099**  
Fig. 6FR  
Fraizer  
15.02mm,cm

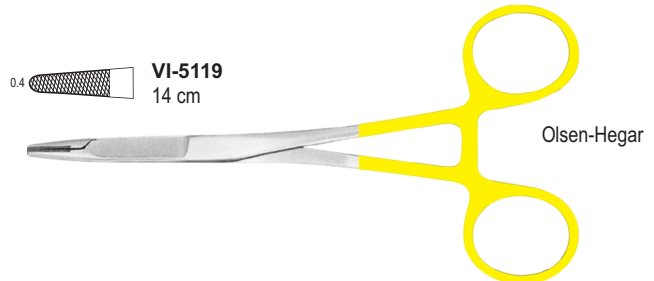
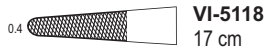
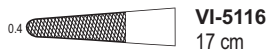
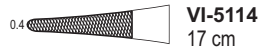
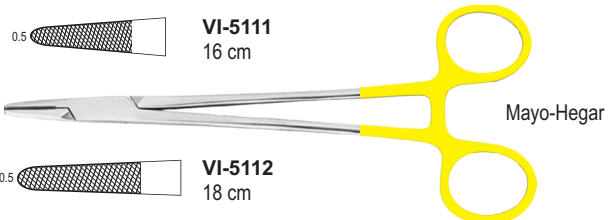
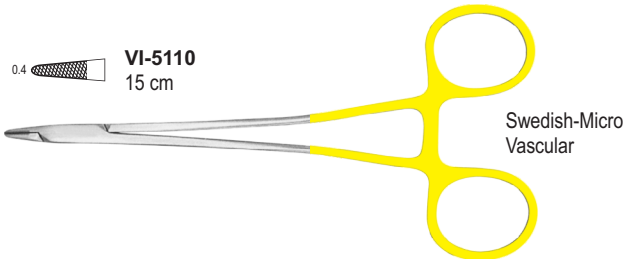
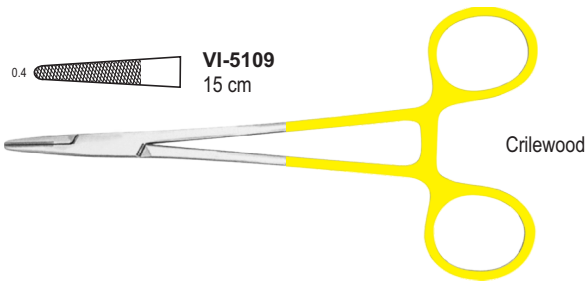
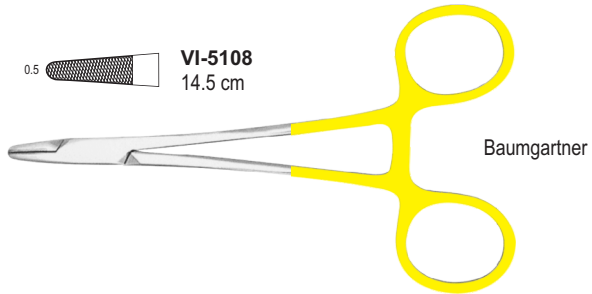
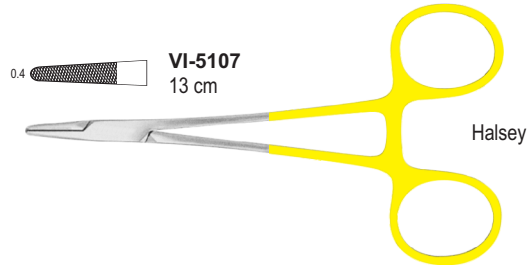
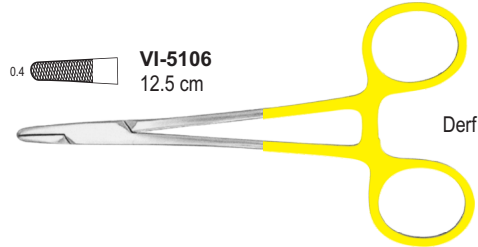

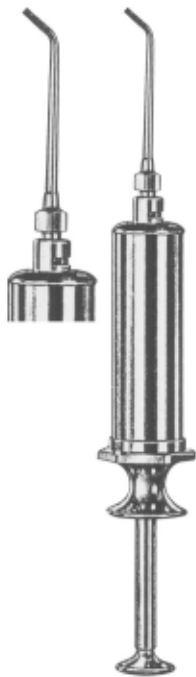

**VI-5121**  
Water Syringe complete with  
1 cannula (Lure-Lock)



**VI-5122**  
Water Syringe complete with  
1 cannula (Lure-Lock)



**VI-5123**  
Metal water syringe, self-filling,  
with 1 cannula (Lure-Lock)



**VI-5124**  
Sparrel Barrel with  
plunger suitable for  
syringes



**VI-5125**  
Cannula, only, with  
Luer-Lock connector  
suitable for syringes



**VI-5126**  
Aspirating Syringe

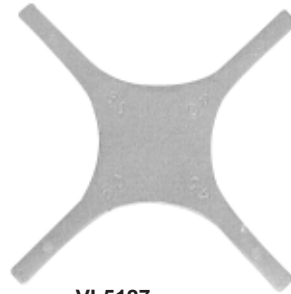

**VI-5127**  
Position Gauge

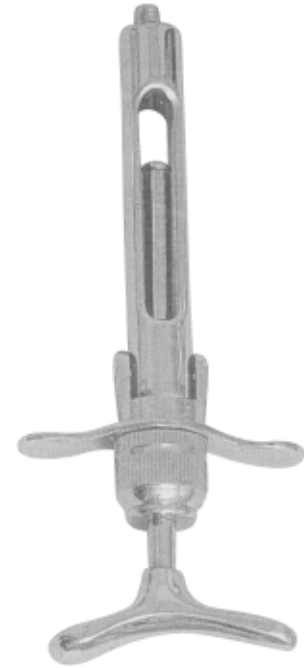

**VI-5128**  
Breech Loading Syringe



**VI-5129**  
Aspirating & Breech Syringe



**VI-5130**  
Band Adaptor



**VI-5131**  
Endo Finger Ruler  
With Adjustable Slide



**VI-5132**  
Aspirating Syringe

Dental Syringes



VI-5133



VI-5134



VI-5135

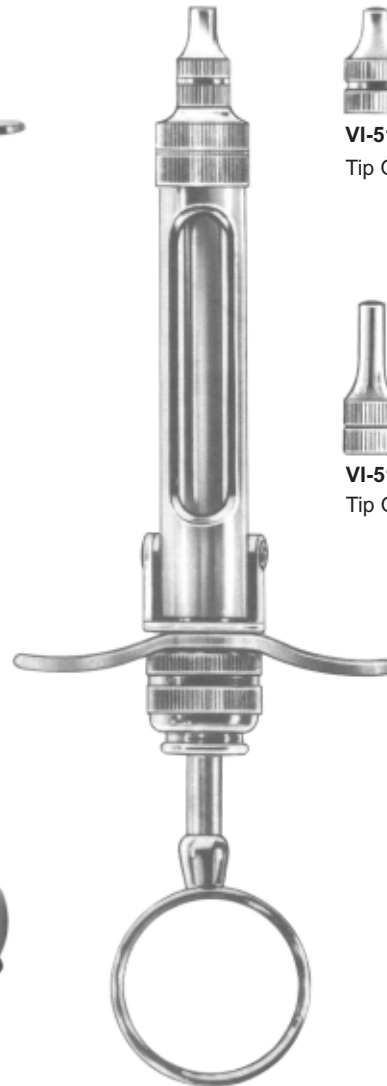

VI-5136 1,8 ml  
VI-5137 2,2 ml

Cartridge Syringe complete  
With 2 tips and without needles



VI-5138  
Tip Only, short



VI-5139  
Tip Only, long



VI-5140



VI-5141



VI-5142



**VI-5143**  
Cork screw tip



**VI-5144**  
Cork screw tip



**VI-5145**  
Folding type, cork screw tip



**VI-5146**  
Folding type, cork screw tip



**VI-5147**



**VI-5148**  
Cork screw tip



**VI-5149**  
Spare cap with metric thread



**VI-5150**  
With Whitworth thread



**VI-5151**

Autoclavable Plastic Protection sleeve



**VI-5152**  
Brass syringe with stainless steel moving parts

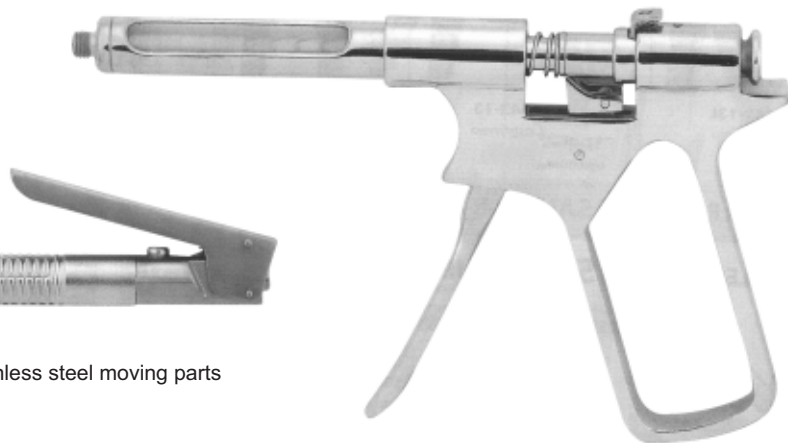

**VI-5153**  
Brass syringe with stainless steel moving parts

Operating Scissors

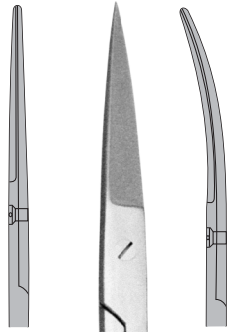

**VI-5154**  
11.5 cm  
**VI-5156**  
13 cm  
**M-054-005**  
14 cm



Standard  
Sharp / Sharp

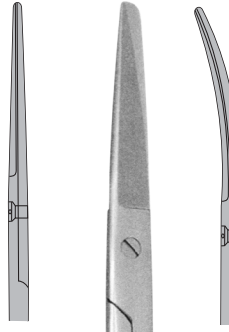

**VI-5158**  
11.5 cm  
**VI-5170**  
13 cm  
**VI-5172**  
14 cm



Standard  
Blunt / Sharp

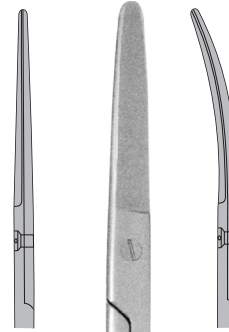

**VI-5174**  
11.5 cm  
**VI-5176**  
13 cm  
**VI-5178**  
14 cm



Standard  
Blunt / Blunt

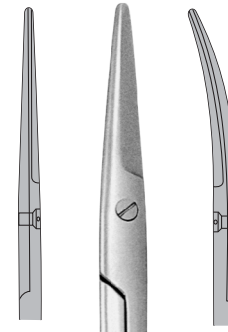

**VI-5180**



Mayo  
14.5 cm

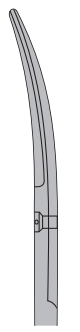

**VI-5181**

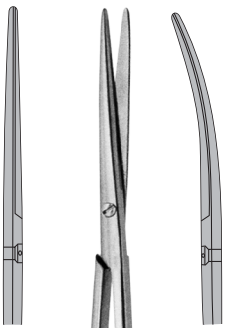

**VI-5182**



Metzenbaum-Delicate  
14.5 cm



**VI-5183**

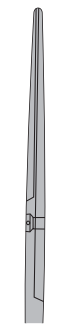

**VI-5184**



Metzenbaum  
14.5 cm



**VI-5185**

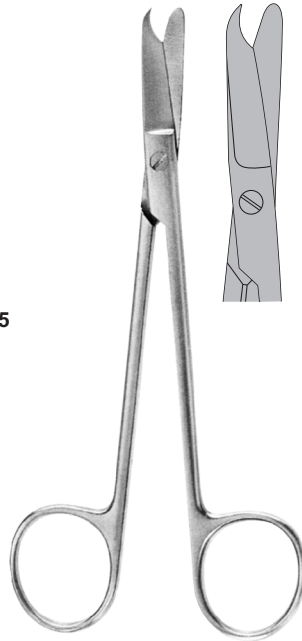

**VI-5186**  
Littauer  
14 cm

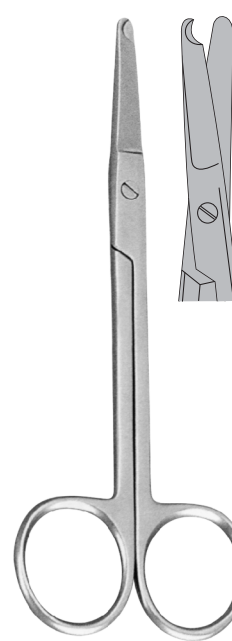

Spencer  
**VI-5187** 9 cm  
**VI-5188** 13 cm



Bandage Scissors Lister  
**VI-5189** 9 cm  
**VI-5190** 11 cm  
**VI-5191** 14 cm  
**VI-5192** 18 cm

Suture Scissors | Tijeras para Hilos | Fadenscheren





Iris  
11.5 cm

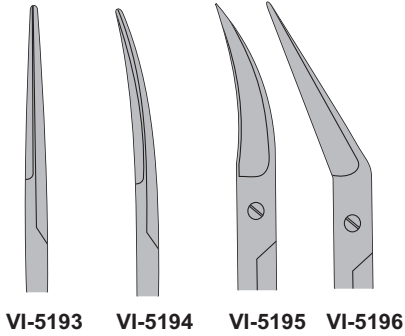

VI-5193 VI-5194 VI-5195 VI-5196

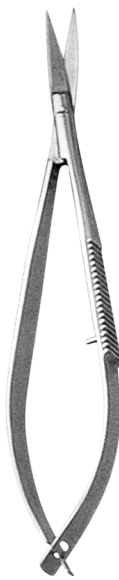

Noyes / Castroviejo  
12 cm

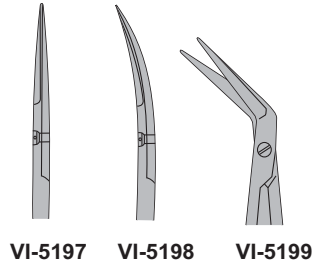

VI-5197 VI-5198 VI-5199

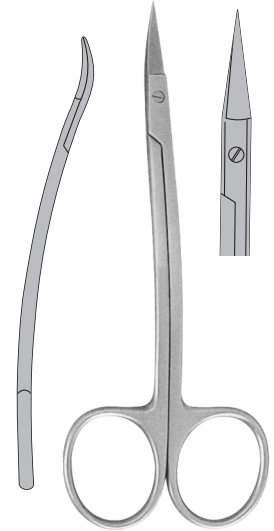

VI-5200  
La Grange  
11.5 cm



VI-5201  
Universal  
18 cm

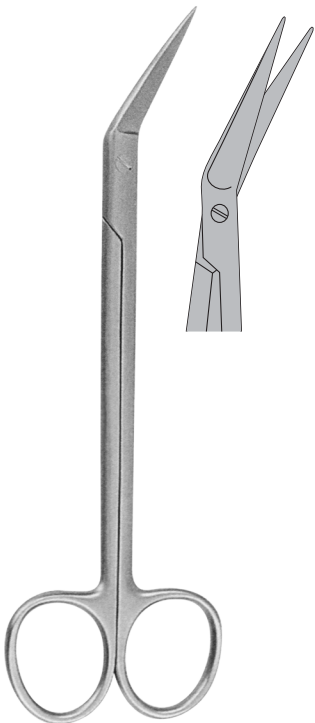

VI-5202  
Kelly  
16 cm

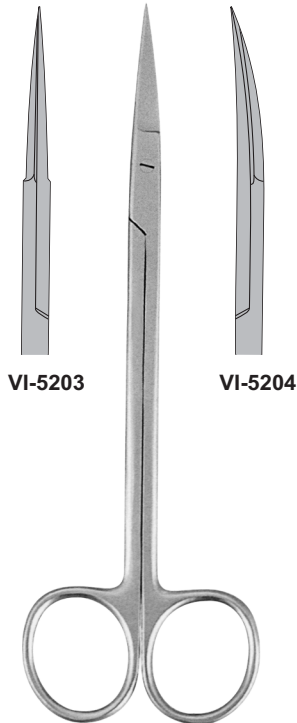

VI-5203 VI-5204

Kelly  
16 cm



VI-5205  
Goldman-Fox  
13 cm

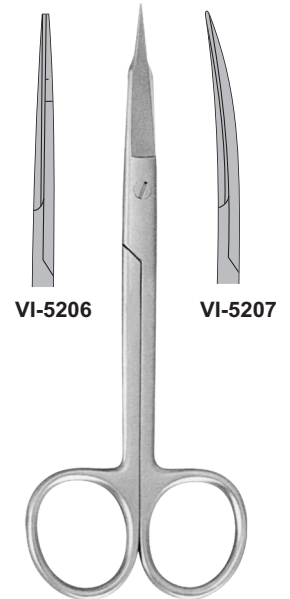

VI-5206 VI-5207

Goldman-Fox  
13 cm

Scissors

**Scissors, One Blade Serrated**

- Manufactured from high quality stainless steel to provide longer-lasting cutting edge.
- Single black ring for easy identification.



Iris  
11.5 cm



Goldman-Fox  
13 cm

VI-5213  
Goldman-Fox  
13 cm

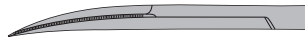

VI-5214

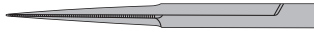

VI-5215

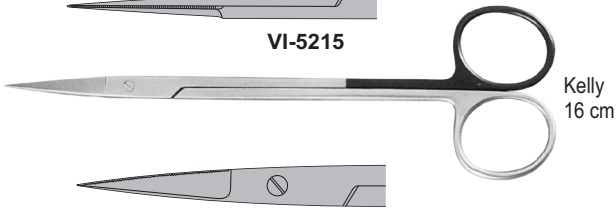

Kelly  
16 cm

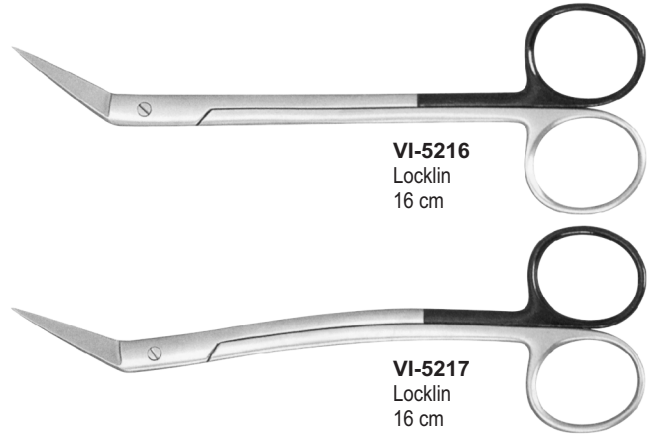

VI-5216  
Locklin  
16 cm

VI-5217  
Locklin  
16 cm

**Super-Cut**

- Cutting Blade horned to "razor" sharpness with opposing blade finished with fine serrations to avoid tissue slippage.
- Extremely smooth cutting with less trauma.
- Manufactured from high quality stainless steel to provide longer-lasting cutting edge.
- Single gold plated ring for easy identification.

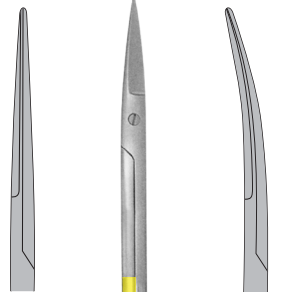

VI-5218

VI-5219



Iris  
11.5 cm

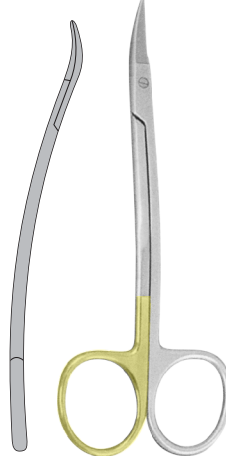

VI-5220  
La Grange  
11.5 cm

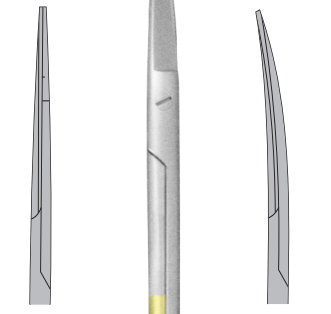

VI-5221

VI-5222



Goldman-Fox  
13 cm



VI-5223

VI-5224

11.5 cm

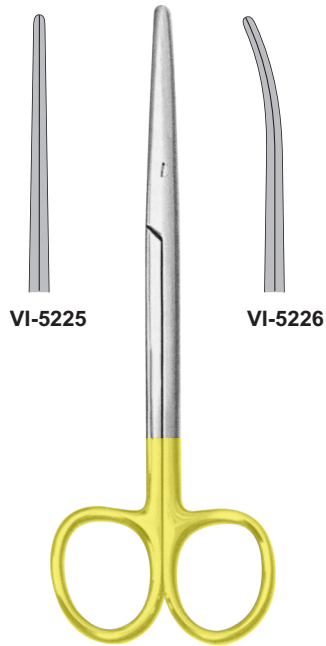

VI-5225

VI-5226

14.5 cm

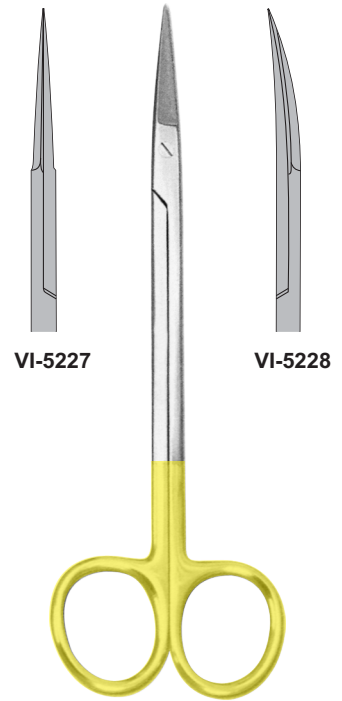

VI-5227

VI-5228

16 cm

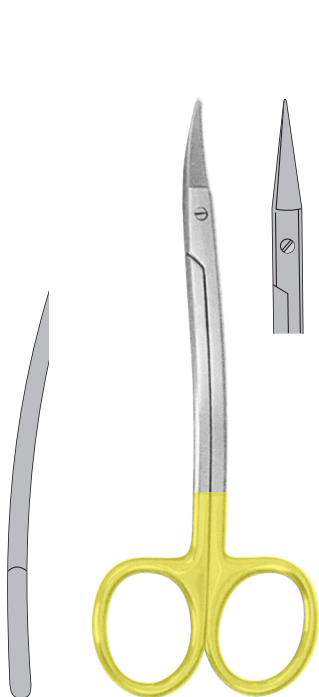

VI-5229  
La Grange  
11.5 cm

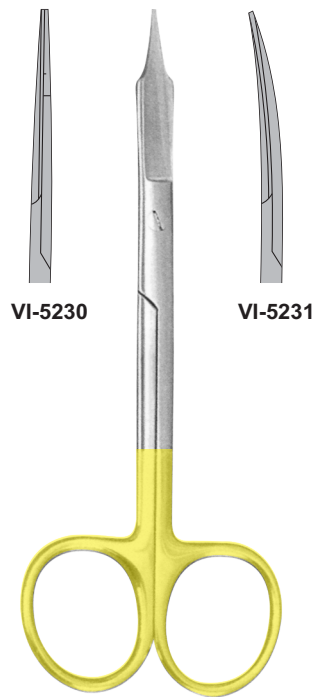

Goldman-Fox  
13 cm

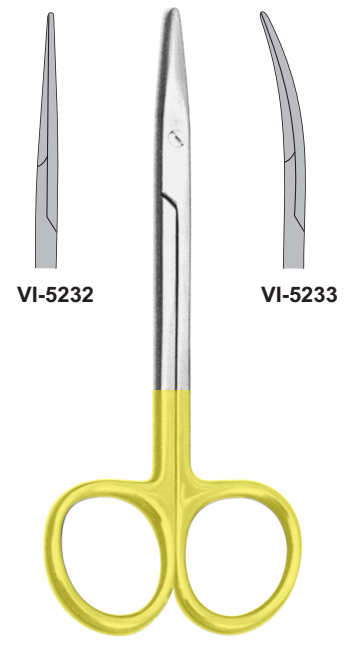

Strabismus  
11.5 cm

Micro Scissors

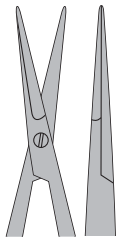
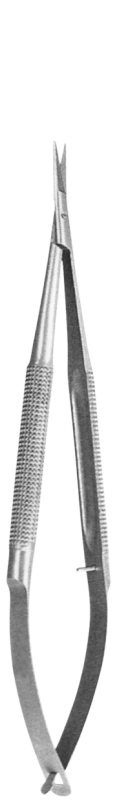

VI-5234  
15 cm

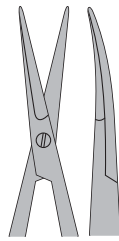

VI-5235  
15 cm

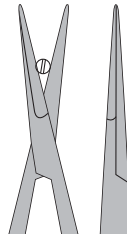
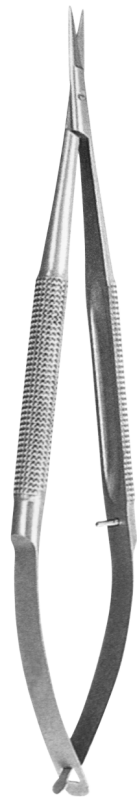

VI-5236  
18 cm

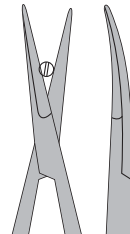

VI-5237  
18 cm

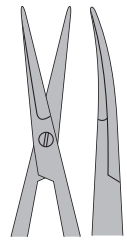

VI-5238  
18 cm

Micro Scissor  
Stainless Steel

Micro Scissor  
Stainless Steel

Micro Scissor  
Stainless Steel  
for ligature, one blade serrated

Micro Scissors with Titanium Stainless Steel Tips

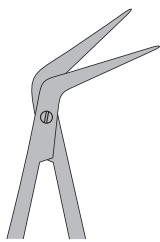
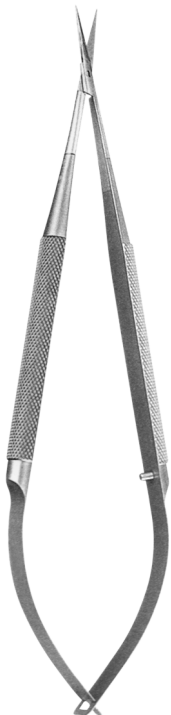

VI-5239  
18 cm

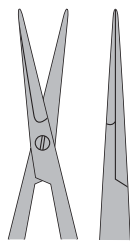

VI-5240  
18 cm

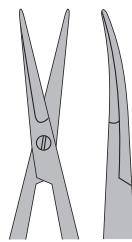

VI-5241  
18 cm

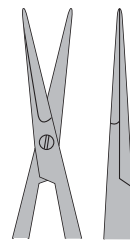

VI-5242  
15.5 cm

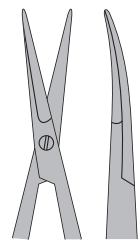

VI-5243  
15.5 cm



**VI-5244**  
College  
15 cm



smooth



**VI-5245**  
College  
15 cm



serrated



**VI-5246**  
College  
15 cm

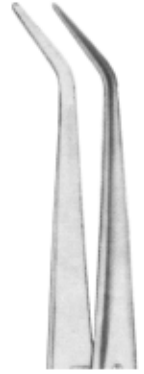

smooth



**VI-5247**  
College  
15 cm



serrated



**VI-5248**  
College  
15 cm

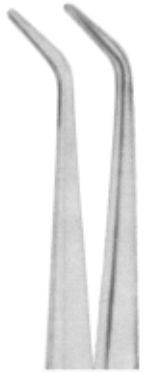

smooth



**VI-5249**  
College  
15 cm



serrated



**VI-5250**  
College  
15 cm



smooth



**VI-5251**  
College  
15 cm



serrated

Dental Tweezers



smooth

VI-5252  
Meriam  
16 cm



serrated

VI-5253  
Meriam  
16 cm



smooth

VI-5254  
Meriam  
16 cm



serrated

VI-5255  
Meriam  
16 cm



smooth

VI-5256  
Meriam  
16 cm



serrated

VI-5257  
Meriam  
16 cm



smooth

VI-5258  
Meriam  
16 cm



serrated

VI-5259  
Meriam  
16 cm

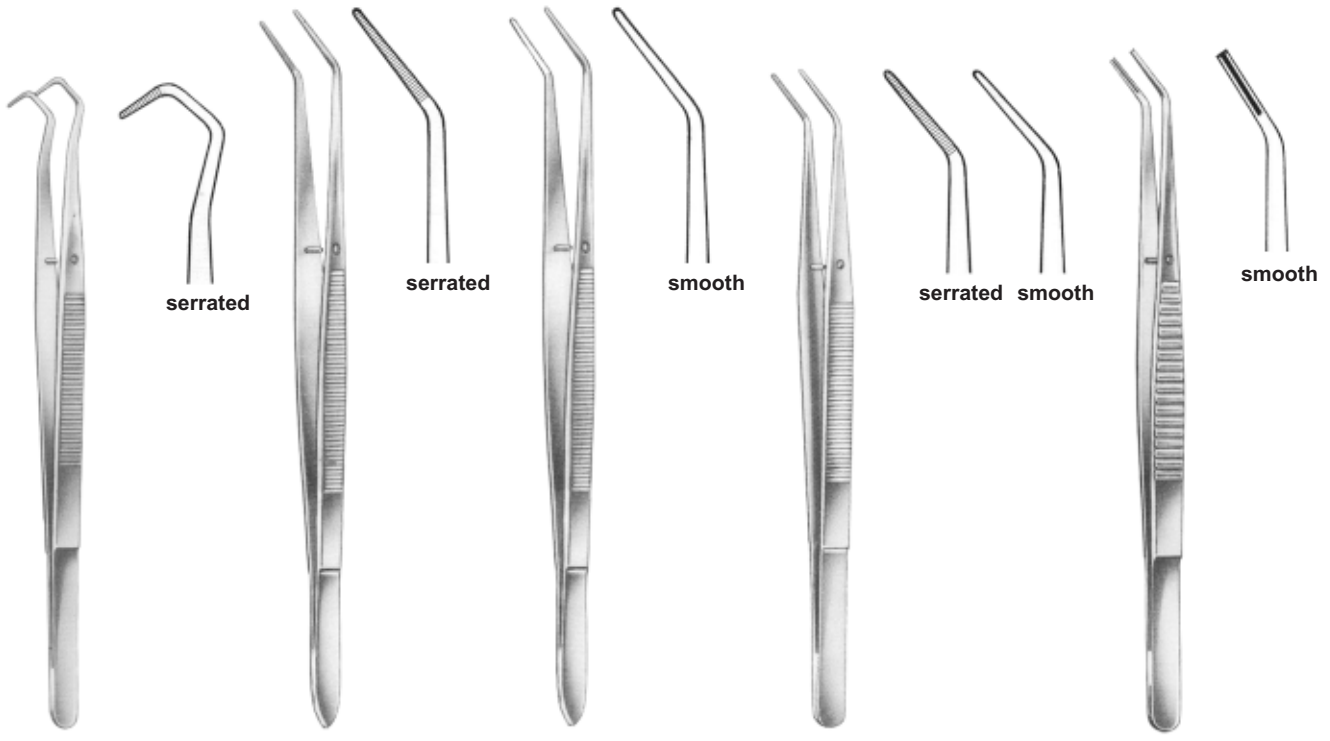

**VI-5260**  
College  
14.5 cm, 5<sup>3</sup>/<sub>4</sub>"

**VI-5261**  
Flagg  
16 cm, 6<sup>1</sup>/<sub>4</sub>"

**VI-5262**  
Flagg  
16 cm, 6<sup>1</sup>/<sub>4</sub>"

**VI-5263**  
Landgraf  
15 cm, 6"

**VI-5264**  
15.5 cm, 6<sup>1</sup>/<sub>8</sub>"

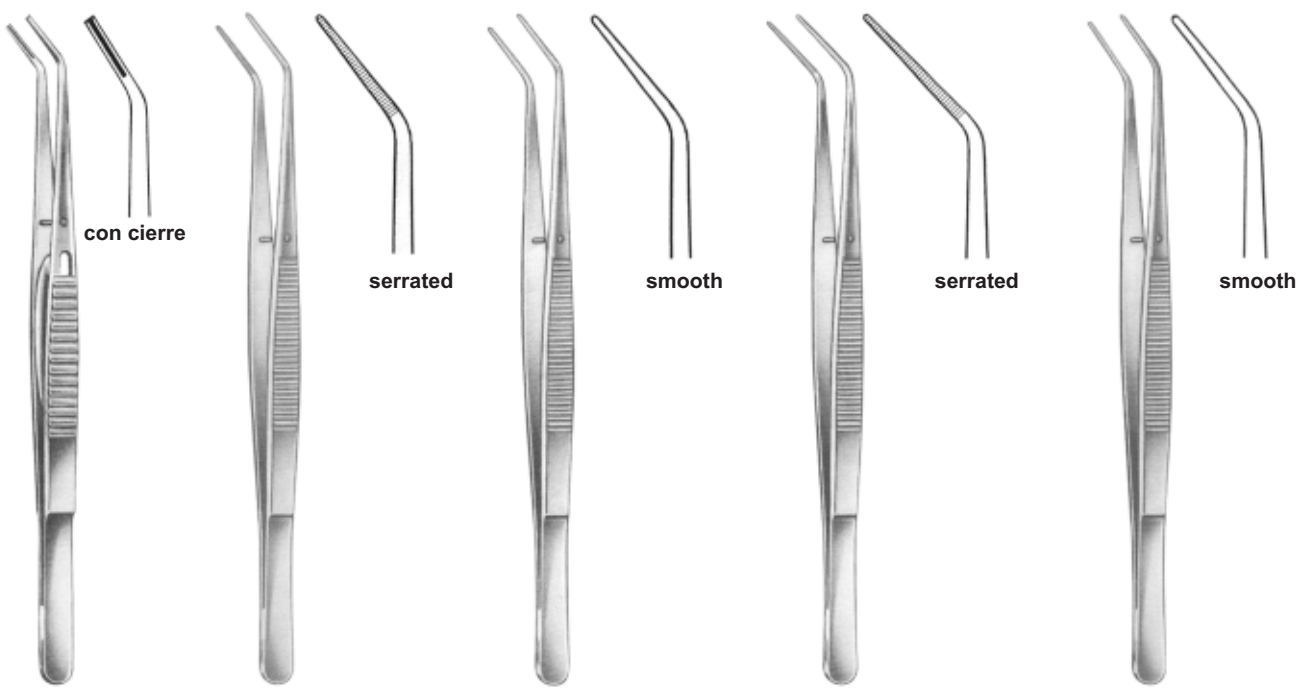

**VI-5265**  
15.5 cm, 6<sup>1</sup>/<sub>8</sub>"

**VI-5266**  
London-College  
15 cm, 6"

**VI-5267**  
London-College  
15 cm, 6"

**VI-5268**  
London-College  
15 cm, 6"

**VI-5269**  
London-College  
15 cm, 6"



Dental Tweezers

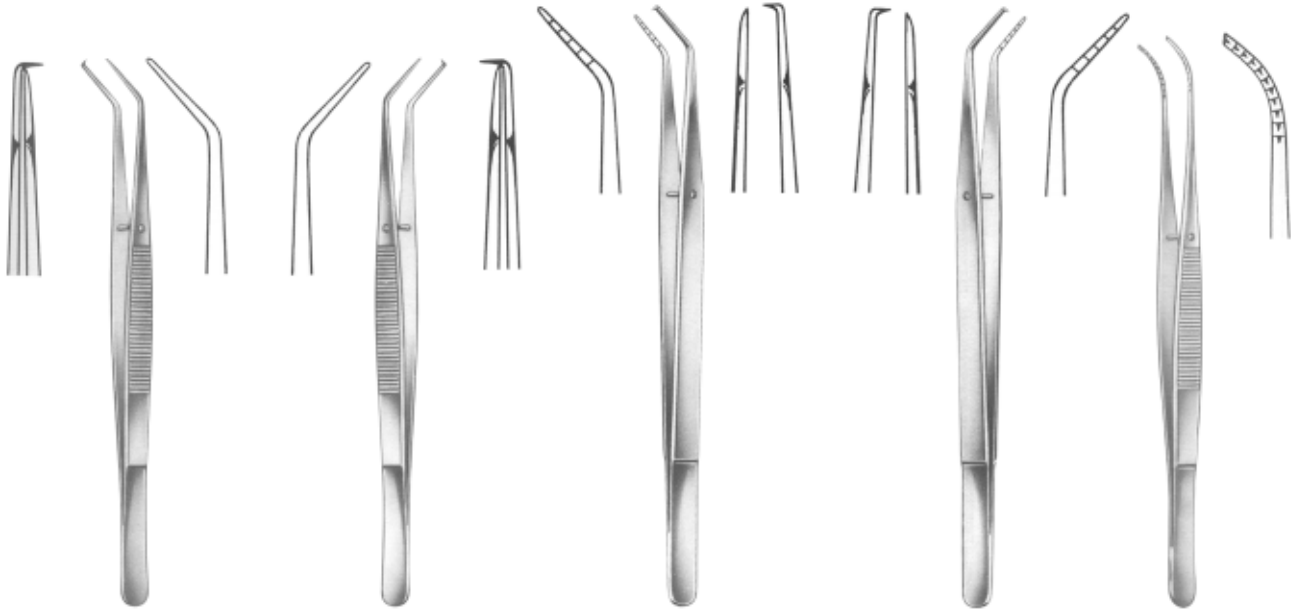

**VI-5270**  
CK1  
15 cm, 6"

**VI-5271**  
CK2  
15 cm, 6"

**VI-5272**  
GF2  
16 cm, 6 1/4"

**VI-5273**  
Gf1  
16 cm, 6 1/4"

**VI-5274**  
Kopp  
15.5 cm, 6 1/8"



**VI-5275**  
Kopp  
15.5 cm, 6 1/8"

**VI-5276**  
15 cm, 6"

**VI-5277**  
16.5 cm, 6 1/2"

**VI-5278**  
15.5 cm, 6 1/8"

**VI-5279**  
15.5 cm, 6 1/8"





**VI-5280**  
London-College  
15 cm, 6"



**VI-5281**  
London-College  
15 cm, 6"



con cierre



**VI-5282**  
Meriam  
16 cm, 6 1/4"



serrated



smooth

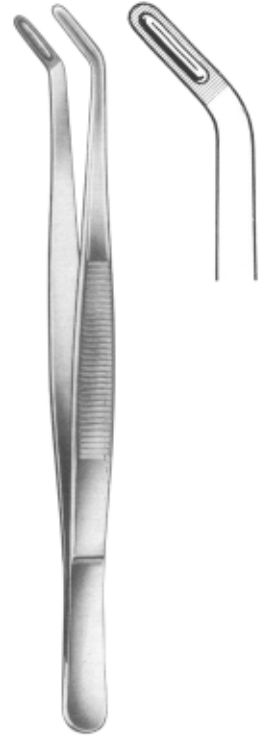

**VI-5283**  
Allen  
18 cm, 7 1/8"

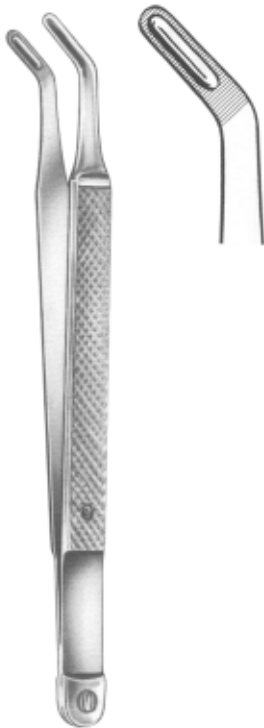

**VI-5284**  
Albrecht  
16 cm, 6 1/4"

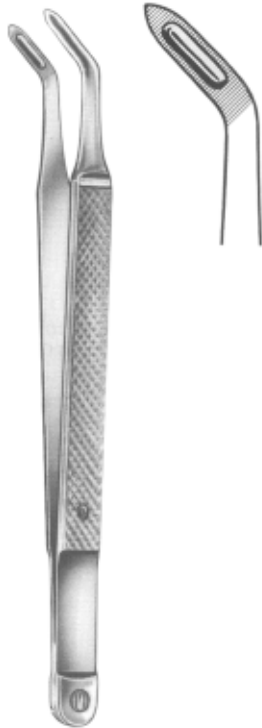

**VI-5285**  
Albrecht  
16 cm, 6 1/4"



**VI-5286**  
16 cm, 6 1/4"



**VI-5287**  
16 cm, 6 1/4"



**VI-5288**  
16 cm, 6 1/4"

Rubber Dam Clamp Forceps



RUBBER DAM FRAME

**VI-5289**  
Young  
105x95 Inox

**VI-5290**  
Ivory  
160 mm

**VI-5291**  
Ainsworth  
170 mm

**VI-5292**  
Ainsworth  
170 mm

**VI-5293**  
Mershan  
140 mm

CLAMPS ( PLIERS )

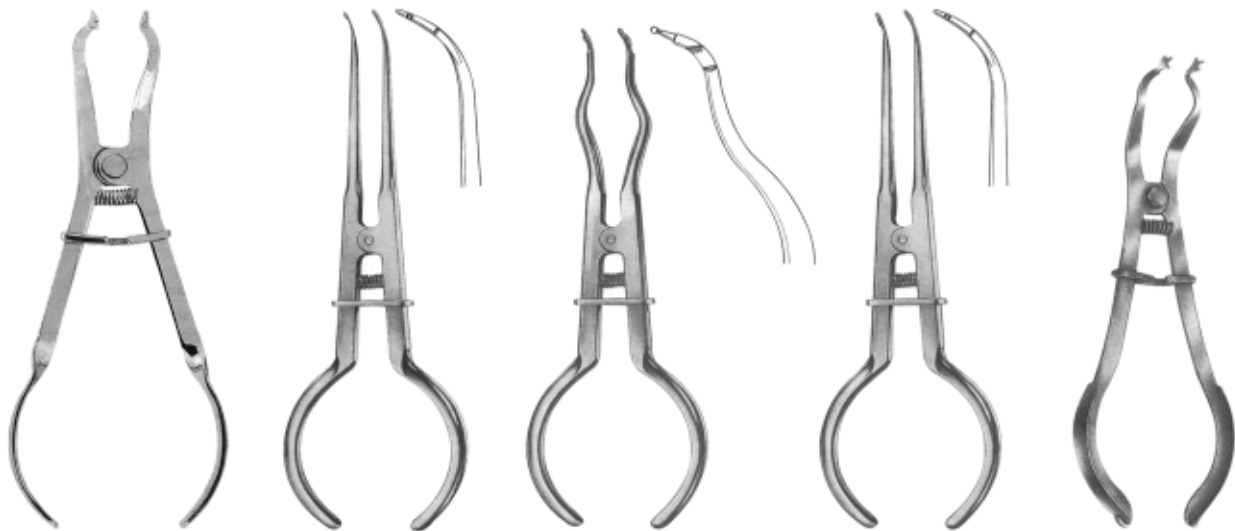

**VI-5294**  
Ivory light weight  
170 mm

**VI-5295**  
Brewer  
175 mm

**VI-5296**  
Brewer  
175 mm

**VI-5297**  
White  
175 mm

**VI-5298**  
Ivory  
170 mm



**VI-5299 - 9**  
Winged  
Labial Clamp



**VI-5303 - 9T**  
Winged  
Edged Labial Clamp



**VI-5307 - 212**  
Winged  
Cervical Clamp



**VI-5314 - 210**  
Winged  
Labial Clamp



**VI-5300 - 00**  
Winged



**VI-5301 - 0**  
Winged



**VI-5302 - W0**  
Wingless

For Small Teeth, Elongated or With Narrow Collars



**VI-5304 - 1**  
Winged



**VI-5305 - 1T**  
Winged



**VI-5306 - W1**  
Wingless

For General Use With Adjustable Jaws According  
To Gingival Line Shapes



**VI-5308 - 2A**  
Winged



**VI-5309 - 2AT**  
Edged, Winged



**VI-5310 - W2A**  
Wingless

For Premolars, With Elongated Collar



**VI-5311 - 2**  
Winged



**VI-5312 - 2T**  
Edged, Winged



**VI-5313 - W2**  
Wingless

For Premolars, With Elongated Collar



**VI-5315 - 29**  
Wingless



**VI-5316 - 60**  
Wingless

Rubber Dam Clamps



VI-5317 - 3  
Winged



VI-5318 - W3  
Wingless

For Small Lower Molars



VI-5319 - 4  
Winged



VI-5320 - W4  
Wingless

For Small Lower Molars With Round clamps



VI-5321 - 7  
Winged



VI-5322 - W7  
Wingless

For Square Lower Molars



VI-5323 - 8  
Winged



VI-5324 - W8  
Wingless

For Round Upper Molars



VI-5325 - 8A  
Winged



VI-5326 - W8A  
Wingless

For Molar Roots



VI-5327 - 12A  
Winged



VI-5328 - 13A  
Wingless

For Partially Broken Molars



VI-5329 - 14  
Winged



VI-5330 - 14T  
Edged Winged



VI-5331 - W14  
Wingless

For Round Molars, Partially Broken, Undersized or Inclined



VI-5332 - 14A  
Winged



VI-5333 - W14A  
Wingless



VI-5334 - 26  
Wingless



VI-5335 - 51  
Wingless



VI-5336 - 202  
Winged



VI-5337 - 205  
Winged



**VAKMAN**  
INDUSTRIES

06

## Page 119-130

- Matrix Retainer, Matrix Bands,
- Crown Removers,scissors, Forceps,
- Amalgum Guns, Carries, Copper Ring Removing
- Pliers, Paper Articulator Forceps

Matrix Retainers and Matrix Bands

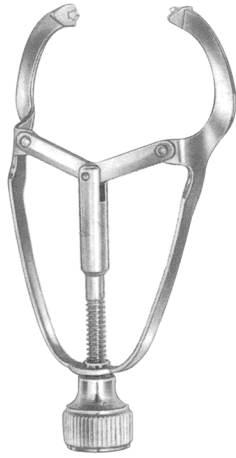

**VI-6000**  
Ivory  
63mm

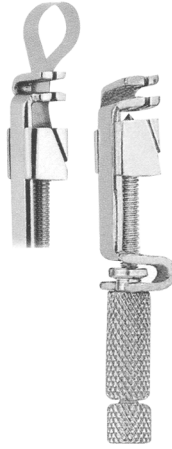

**VI-6001-1**  
Tofflemire-Universal

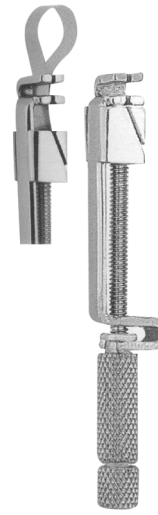

**VI-6002-2**  
Tofflemire-Junior

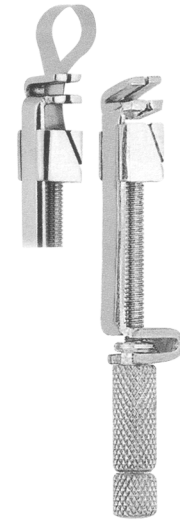

**VI-6003-3**  
Tofflemire-Senior



**VI-6004-5**  
Ivory 8  
5 mm



**VI-6005-6**  
Ivory 8  
6 mm



**VI-6006**  
Ivory 8  
7 mm



**VI-6007**  
Ivory 8 N

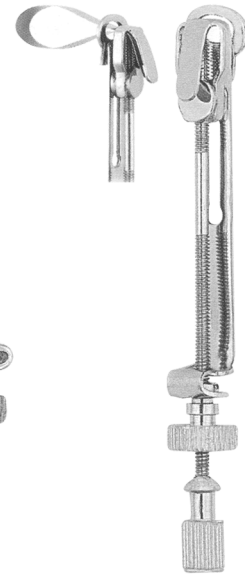

**VI-6008**  
Didner 8 P

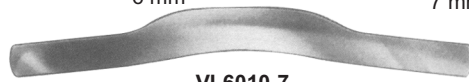

**VI-6010-7**



**VI-6011-8**



**VI-6012-9**

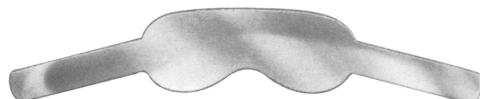

**VI-6013-10**

1750-5 mm x 100 cm  
1750-6 mm x 100 cm  
1750-7 mm x 100 cm



**VI-6009**

For Molars and Premolars



**VI-6014-11**



**VI-6015-12**



**VI-6016-13**

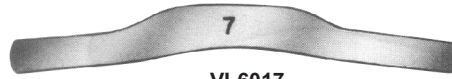

7  
VI-6017  
Molar  
Fig 7



8  
VI-6018  
Molar  
Fig 8



9  
VI-6019  
Molar  
Fig 9

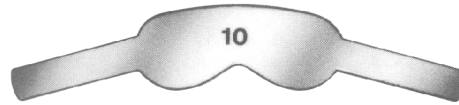

10  
VI-6020  
Molar  
Fig 10



1  
VI-6021  
Tofflemire



2  
VI-6022  
Tofflemire



3  
VI-6023  
Tofflemire



11  
VI-6024  
Bicuspid



12  
VI-6025  
Bicuspid



13  
VI-6026  
Bicuspid



1  
VI-6027  
Bicuspid



2  
VI-6028  
Bicuspid



3  
VI-6029  
Bicuspid



VI-6033



1  
VI-6030  
Molar



2  
VI-6031  
Molar



3  
VI-6032  
Molars



Dental Crown Removers

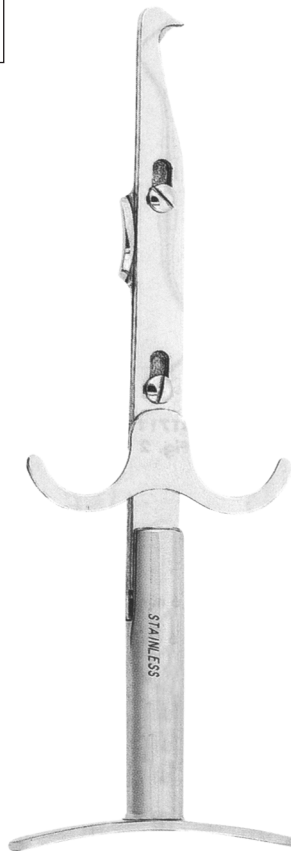
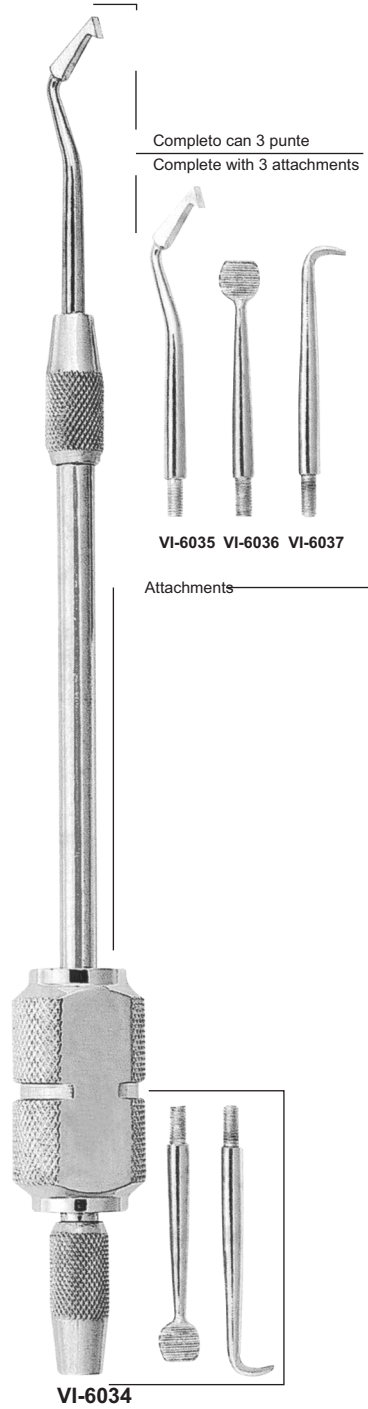

**VI-6038**  
Crown Spreader, Crown Remove.  
Special instrument for crown spreading  
after separating, simple and safe  
operation.

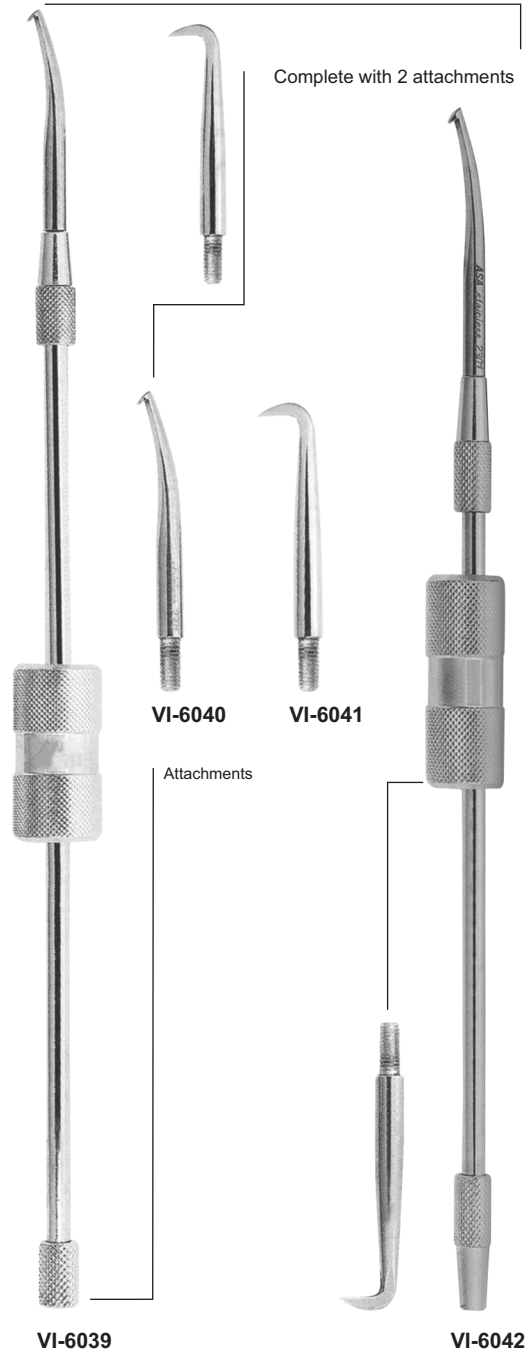





Universal "HM"  
12 cm, 4 3/4"

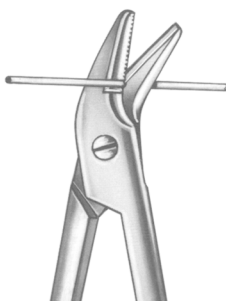

VI-6043

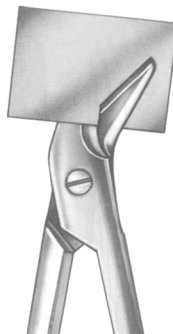

VI-6044

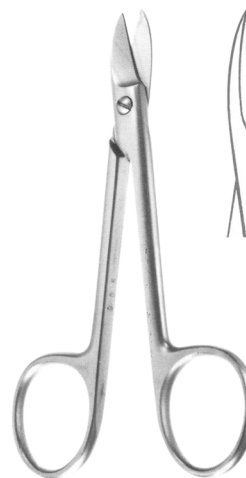

VI-6045  
Beebe  
10,5 cm, 4 1/8"



VI-6046  
Mershon



VI-6047  
Morell



VI-6048  
Morell



VI-6049  
Morell



VI-6050  
Morell



VI-6051  
Treyman

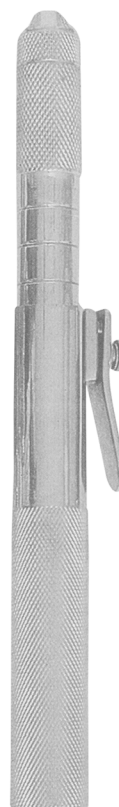

VI-6052  
Automatic Crown Remover  
With 2 Points



VI-6053



VI-6054

Amalgum Guns and Carreirs

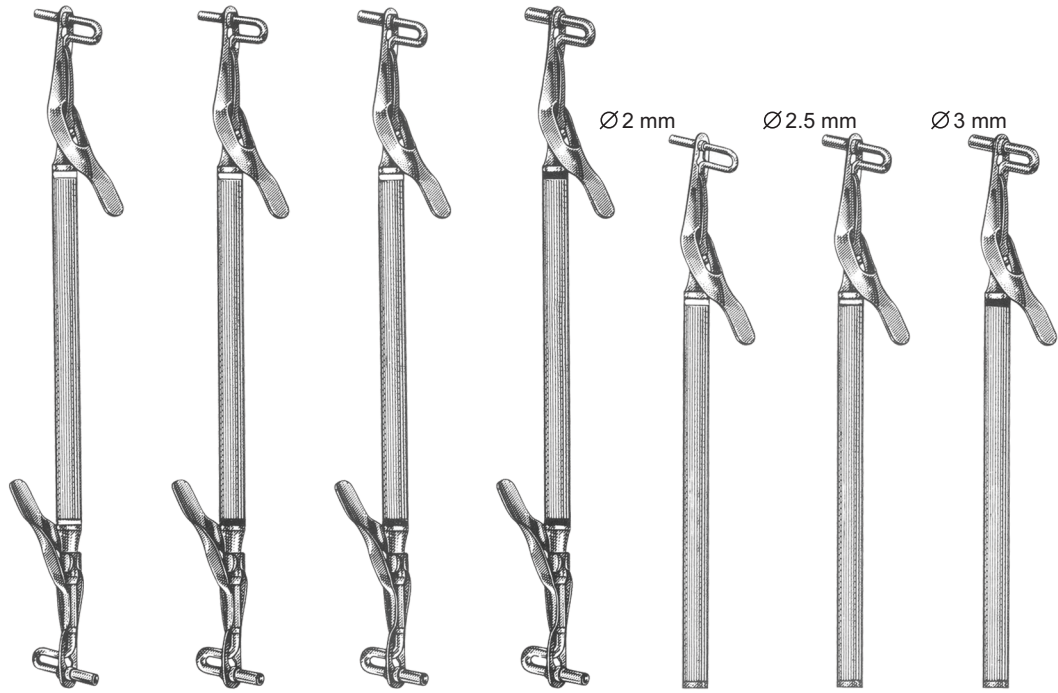

**VI-6055**  
Medium-Large  
20 cm

**VI-6056**  
Medium-Jumbo  
20 cm

**VI-6057**  
Large-Jumbo  
20 cm

**VI-6058**  
Jumbo-Jumbo  
20 cm

**VI-6059**  
Medium  
15.5 cm

**VI-6060**  
Large  
15.5 cm

**VI-6061**  
Jumbo  
15.5 cm

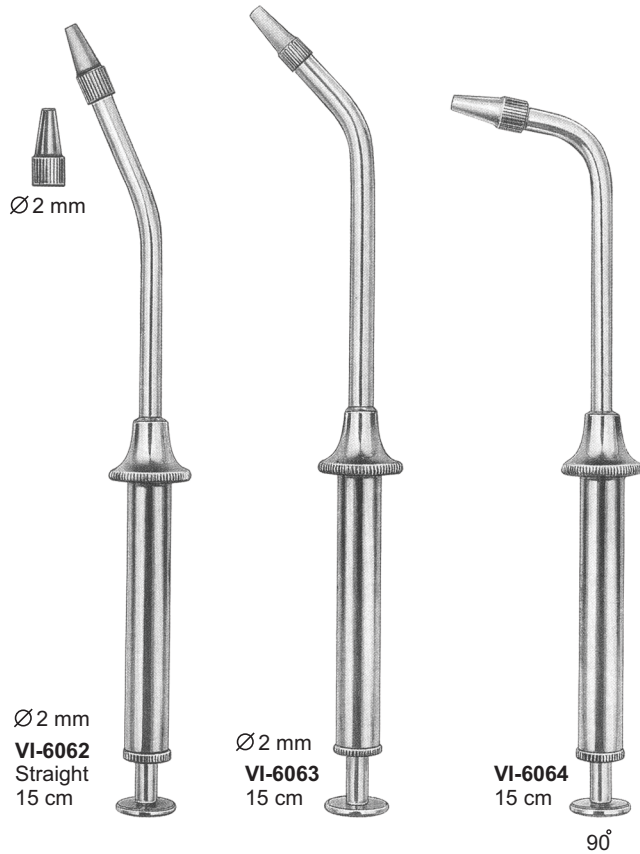

**Ø 2 mm**

**Ø 2 mm**  
**VI-6062**  
Straight  
15 cm

**Ø 2 mm**  
**VI-6063**  
15 cm

**VI-6064**  
15 cm

90°

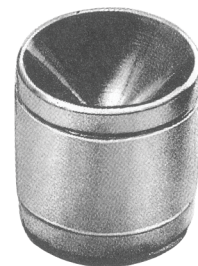

**VI-6065**  
Amalgam Well  
Non Skid Base  
Ø 3.5 mm



Copper ring removing pliers



**VI-6066**  
Bohm  
11,5 cm

**VI-6067**  
Bohm  
14,5 cm

**VI-6068**  
Furrer  
16 cm

**VI-6069**  
Furrer  
16 cm

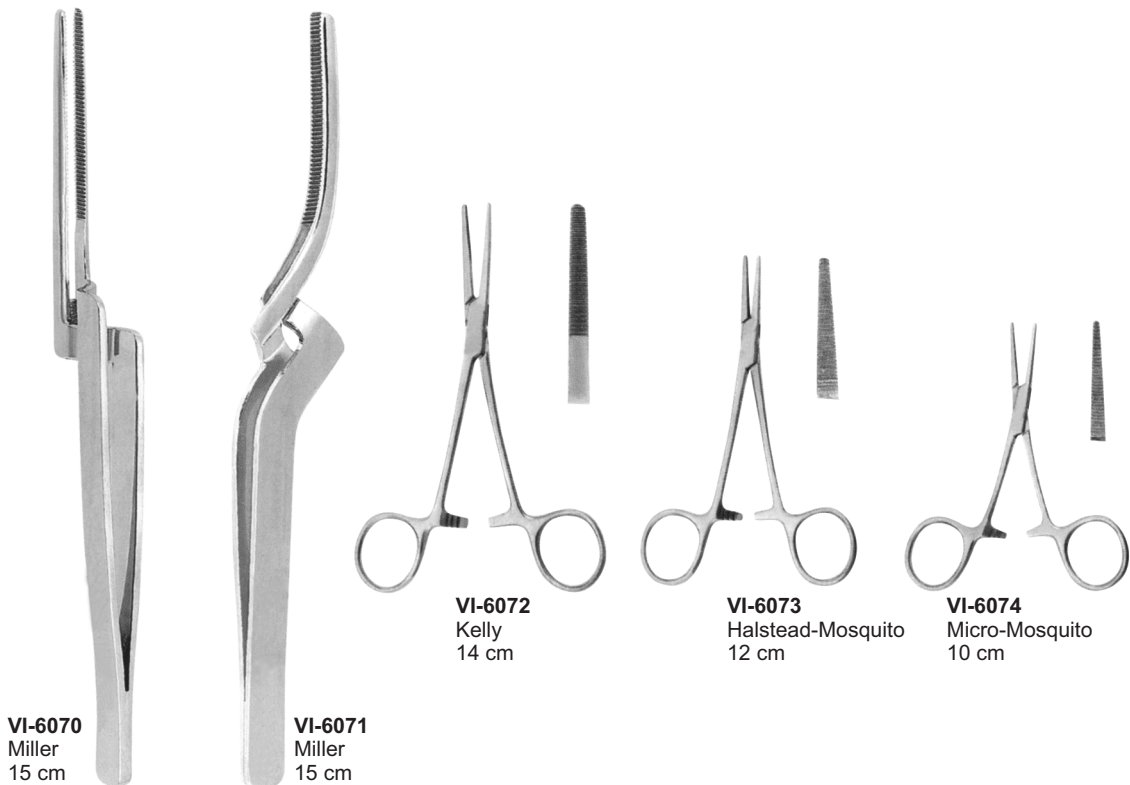

**VI-6070**  
Miller  
15 cm

**VI-6071**  
Miller  
15 cm

**VI-6072**  
Kelly  
14 cm

**VI-6073**  
Halstead-Mosquito  
12 cm

**VI-6074**  
Micro-Mosquito  
10 cm

Rongeurs

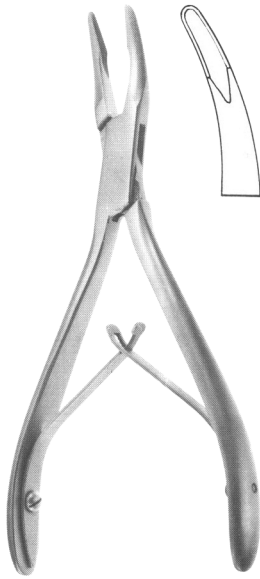

**VI-6075**  
Friedmann  
14 cm, 5 1/2"

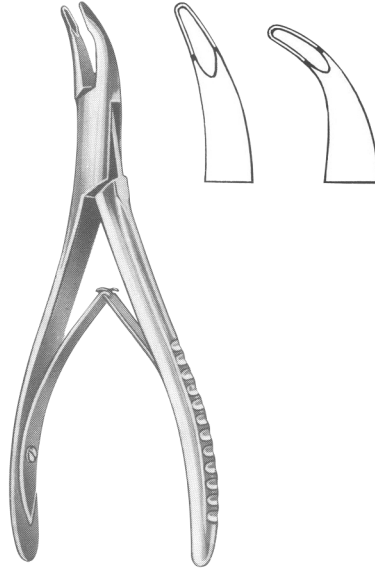

**VI-6076**  
Mead  
14 cm, 5 1/2"

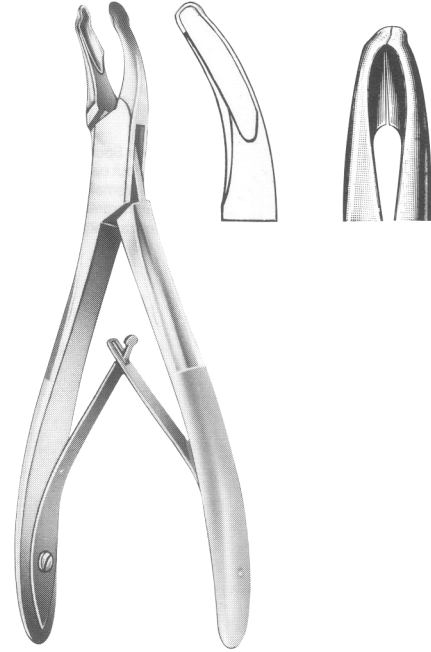

**VI-6077**  
Mead  
14 cm, 5 1/2"

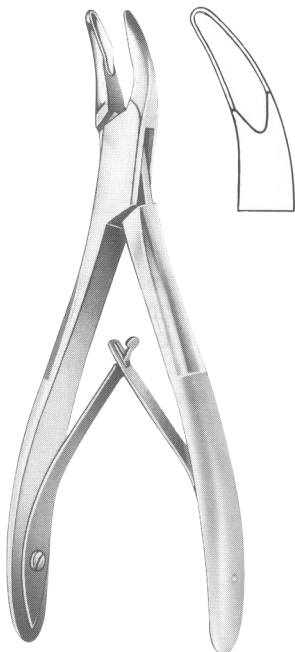

**VI-6078**  
Mead  
14 cm, 5 1/2"



**VI-6079**  
Mead  
17 cm, 6 3/4"

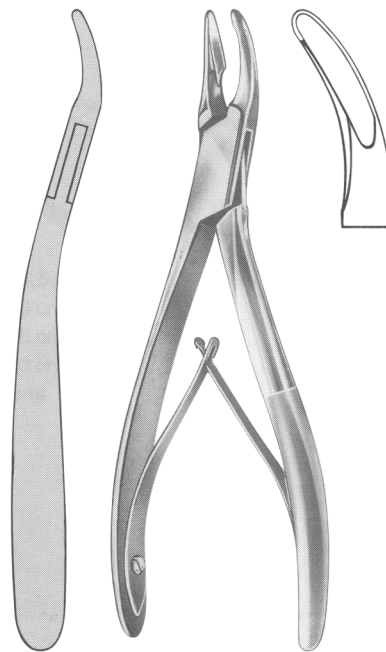

**VI-6080**  
Schell  
17 cm, 6 3/4"



**VI-6081**  
Luer  
15 cm



**VI-6082**  
Friedman  
14 cm



**VI-6083**  
Mini Friedman  
12 cm



**VI-6084**  
Goldman-Fax  
10 cm



**VI-6085**  
Blumenthal  
15 cm



**VI-6086**  
Blumenthal 45  
14,5 cm



**VI-6087**  
Blumenthal 90  
14 cm



**VI-6088**  
Bohler  
15 cm



**VI-6089**  
Kerrison  
15 cm

Rongeurs

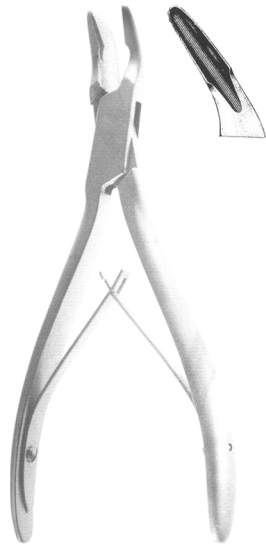

**VI-6090**  
Blumenthal  
16 cm, 6 1/4"

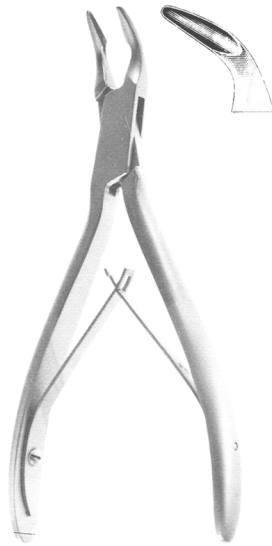

**VI-6091**  
Blumenthal  
16 cm, 6 1/4"

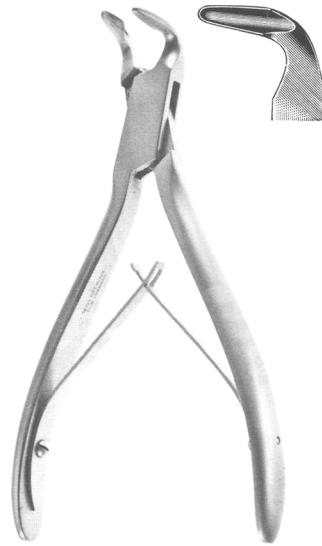

**VI-6092**  
Blumenthal  
16 cm, 6 1/4"

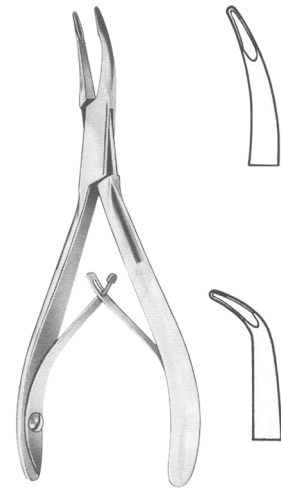

**VI-6093**  
Kleinert-Kutz  
14 cm, 5 1/2"



**VI-6094**  
Ruskin-Mini  
15 cm

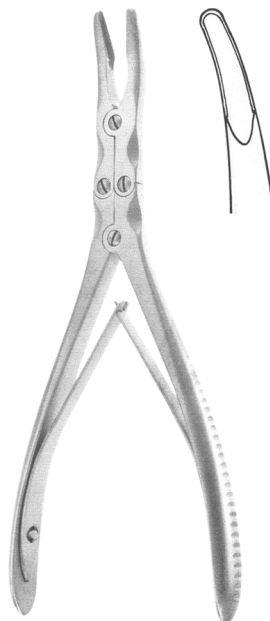
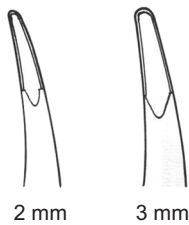

**VI-6095**  
Beyer  
18 cm, 7 1/8"



**VI-6096**  
Zaufal-Jansen  
18 cm, 7 1/8"



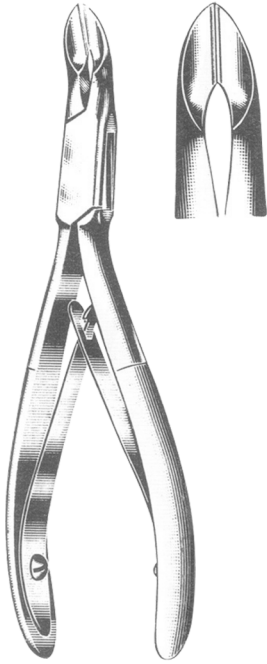

**VI-6097**  
Niro  
No. 5 S, 14 cm, 5 1/2"

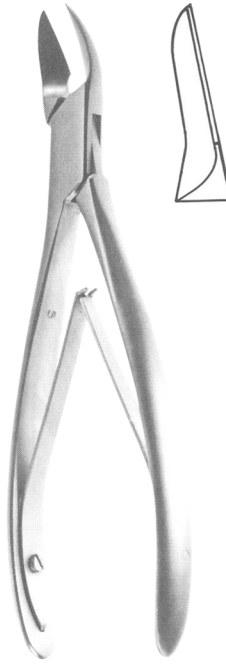

**VI-6098**  
Cleveland  
No. 5 S, 17 cm, 6 3/4"

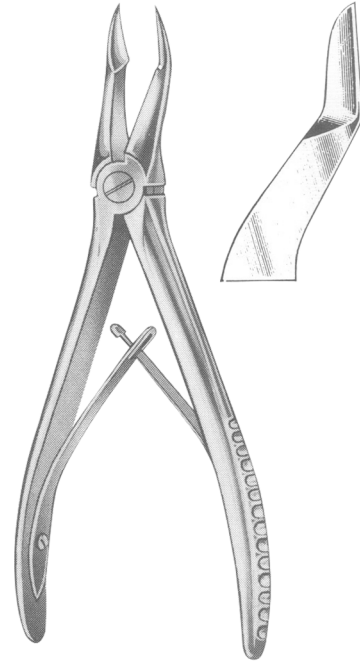

**VI-6099**  
No. 18, 15 cm, 6"

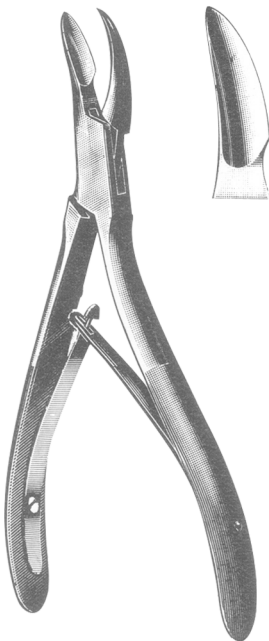

**VI-6100**  
Cleveland  
16 cm, 6 1/4"



**VI-6101**  
Gardner  
16 cm, 6 1/4"



**VI-6102**  
Liston-mini  
15 cm, 6"

Bone Elevators

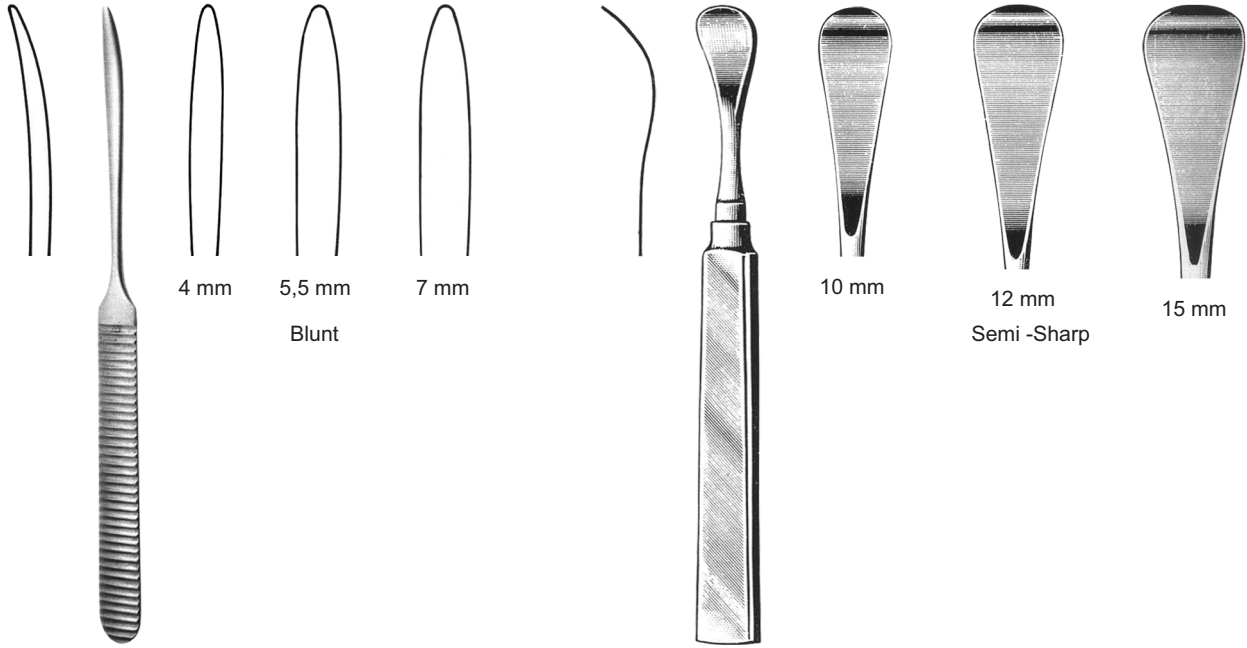

**VI-6103**  
Williger  
16 cm, 6 1/4"

**VI-6104**  
Henahan  
17 cm, 6 3/4"

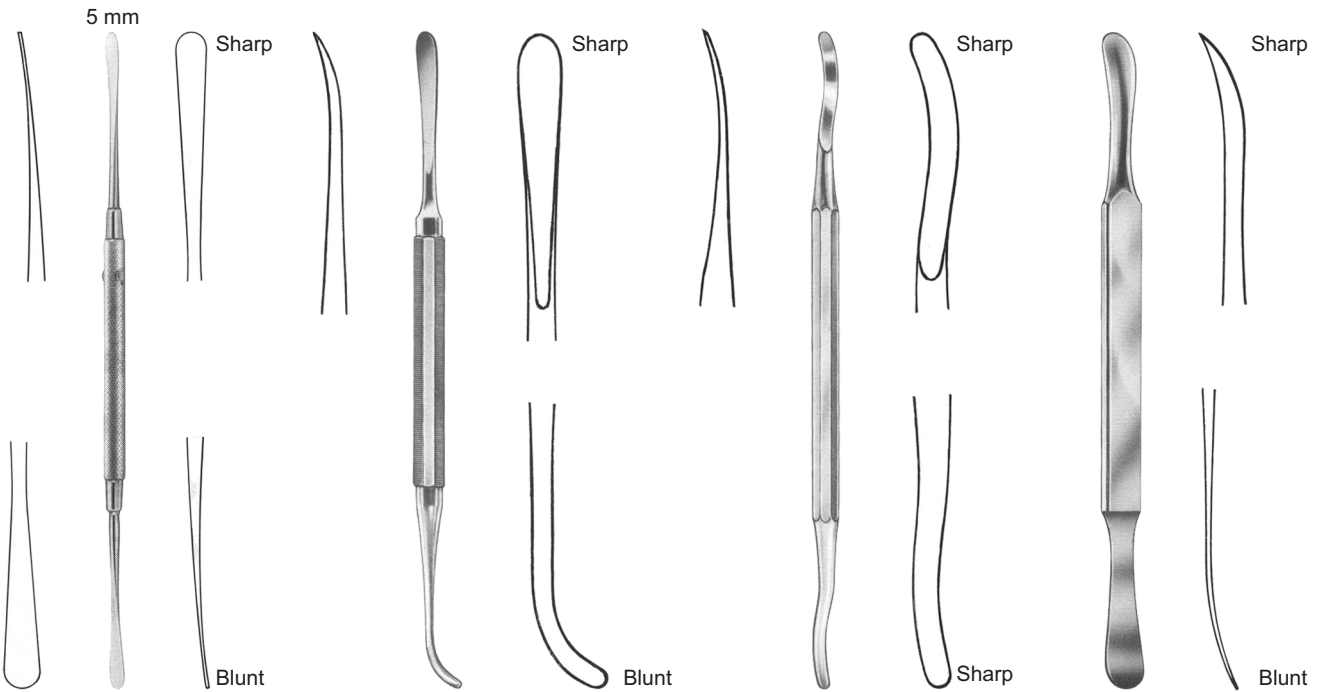

**VI-6105**  
Freer  
19 cm, 7 1/2"

**VI-6106**  
Bennet  
17 cm, 6 3/4"

**VI-6107**  
Seldin  
19 cm, 7 1/2"

**VI-6108**  
Seldin  
19,5 cm, 7 3/4"



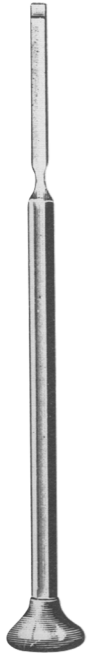

**Buckley**  
15 cm, 6"



**VI-6109**  
No. 1  
3mm



**VI-6110**  
No. 2  
4mm



**VI-6111**  
No. 3  
5mm



**VI-6112**  
No. 4  
4mm



**VI-6113**  
No. 5  
4mm



**VI-6114**  
Killian  
16 cm, 6 1/4" 5 mm

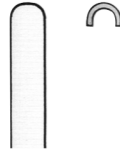

**VI-6115**  
Killian-Claus  
16 cm, 6 1/4" 5 mm

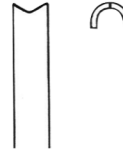

Obwegeser



**VI-6116**  
2,5 mm



**VI-6117**  
4 mm



**VI-6118**  
Miller  
No. 10C



**VI-6119**  
Miller  
No. 11C



**VI-6120**  
Miller  
No. 12C



**VI-6121**  
Miller  
No. 13C





**VAKMAN**  
INDUSTRIES

**07**

# Page 131-168

- Pliers For Orthodontics
- & Impression Trays

Pinze per formare loops  
Loops forming pliers



**VI-7000**  
Adams

Adams pliers for bending  
wires up to 0,7mm. (.28").

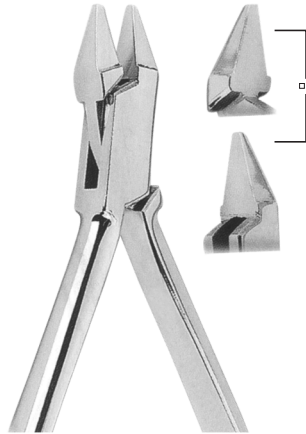

**VI-7001**  
Adams

Adams pliers for bending  
wires up to 0,7mm. (.28").

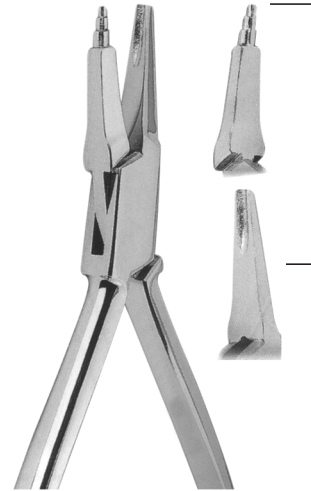

**VI-7002**  
Adams

Tweed loop forming pliers.  
For forming loop in wires up  
to 0,56 mm. (.22").



**VI-7003**  
Adams

Aderer three jaws bending  
pliers. For wires up  
to 0,7 mm. (.28").

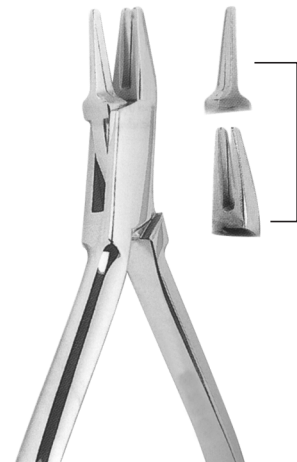

**VI-7004**  
Adams

Aderer three jaws bending  
pliers. For wires upto 0,7 mm.  
(.28").

## Ligature Cutter Pliers

**VI-7005**

Micro-miniature light wire cutter. It cuts soft ligature wires. For use in caso of limited access. Caution: maximum cutting capacity: soft ligature wire up to 0,30 mm. (.012").

**VI-7006**

Wire cutter. For ligature wires and pins. It is strong enough to bend archwire ends after distal cutting. Maximum cutting capacity up to 0,56 x 0,7 mm. (.022" x .028").

**VI-7007**

Wire cutter. For ligature wires and pins. It is strong enough to bend archwire ends after distal cutting. Maximum cutting capacity: up to 0,9 mm. (.036").

**VI-7008**

Wire cutter. For ligature wires and pins. It is strong enough to bend archwire ends after distal cutting. Maximum cutting capacity: up to 1,5 mm. (.044").

Pinze per formare laboratorio  
Laboratory pliers



**VI-7009**

Flat nose pliers with smooth beaks for bending wires up to 0,7 mm. (.028").



**VI-7010**

Bending wires up to 0,7 mm. (.028").



**VI-7011**

Bending wires up to 0,7 mm. (.028").



**VI-7012**

Bending wires up to 0,7 mm. (.028").

Pliers for Othodontics



**VI-7013**  
Nance  
Nance loop closing pliers, for bending of stop loops and special for Adams' clasps. Wires up to 0,7 mm. (.028").



**VI-7014**  
Nance  
Universal pliers for bending wires up to 0,9 mm. (.035") or cutting up to 0,7 mm. (.028").

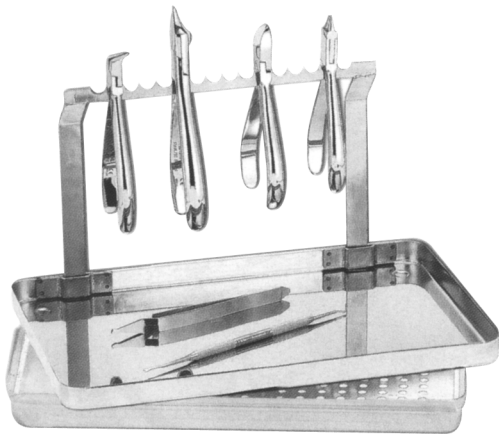

**VI-7015**  
Stainless steel pliers tray standard dimensions



**VI-7016**  
Universal  
Universal pin roughening, cutting and bending pliers. Forwires up to 0,9 mm. (.035"). Will cut wires up to 0,7 mm. (.028").

Utility and specialty pliers



**VI-7017**  
Reynolds

Reynolds contouring pliers.



**VI-7018**  
Reynolds

Lingual arch pliers used to form double and triple back bends in 0,7 mm (.028") or 0,9 mm (.035") wire for insertion in lingual sheaths.



**VI-7019**  
Weingart

Weingart pliers with serrated points.

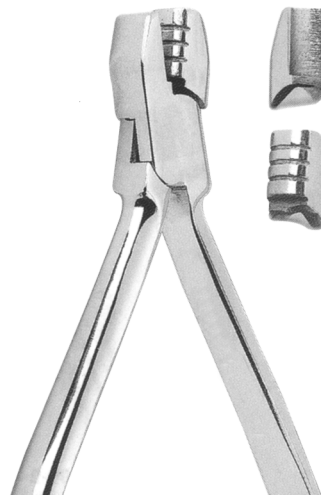

**VI-7020**  
De La Rosa

De La Rosa arch forming pliers. Designed to form and contour arch wires on round or rectangular wire. The beak has grooves of 0,4 mm (.016"), 0,46 mm (.018") and 0,56 mm (.022").



**VI-7021**  
De La Rosa

Arch forming pliers with a non grooved contouring surface the forming of precise arches.



Pliers for Othodontics

Loop formare pliers



**VI-7022**  
Waldsachs

Waldsachs universal pliers for bending wires up to 1,0 mm. (.039") or cutting up to 0,7 mm. (.028").



**VI-7023**

Round and Concave pliers for loop forming and bending of thin round and square wires up to 0,5 mm. (.020").

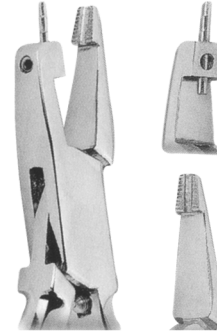

**VI-7024**  
Tweed

Tweed loop Forming Pliers. For round or rectangular wires up to 0,56 x 0,7 mm. (.022" x .028"). Replaceable cylindrical beak with three sizes: 1,15 mm. (.045), 1,50 mm. (.059"), 1,90 mm. (.075"). Concave beak with slight parallel serrations, to keep the wire in proper position.

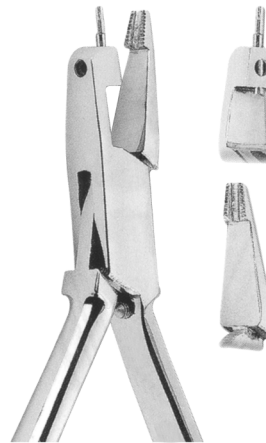

**VI-7025**  
Tweed

Tweed Loop Forming Pliers. For making perfect Omega Loops with round or rectangular wires up to 0,56 x 0,7 mm. (.022" x .028"). The concave beak is exactly the same as pliers 5809-1

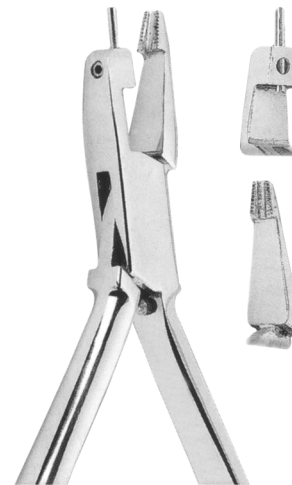

**VI-7026**  
Tweed

Single diameter loop forming pliers. Wire up to 0,56 x 0,7 mm. (.022" x 0.28"). Replaceable concave beak has only one diameter section of 1,50 mm. (.059").



**Distal end cutters**



**VI-7027**

Distal end cutter -safety hold- a precision cutter designed for distal arch cutting in the patient's mouth. It cuts hard wires end holds the loose distal end preventing any damaging of oral tissue. Maximum cutting capacity rectangular wires up to 0,56 x 0,7 mm. (.022" x .020").



**VI-7028**

Micro- distal end cutter - safety hold-. Similar to 3227



**VI-7029**

Direct bonding bracket remover (wide). The removal grip firmly for easy incisal-gingival (vertical) use or, if needed, for mesial-distal (horizontal) use with the same ease.

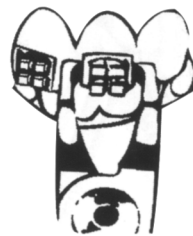

**VI-7030**

Direct bond attachment remover (angled). For removing all bonded attachments. May be used mesial-distal-horizontal) or incisal-gingival (vertical) in anterior areas. Angled perfectly for easy access to difficult posterior areas.

Pliers for Othodontics

Bird beak pliers



**VI-7031**

Wire bending pliers. For wires up to 0,9 mm. (.036").



**VI-7032**

Bird Beak Angle pliers for bending round, square or rectangular wire up to 0,7 mm. (.028").

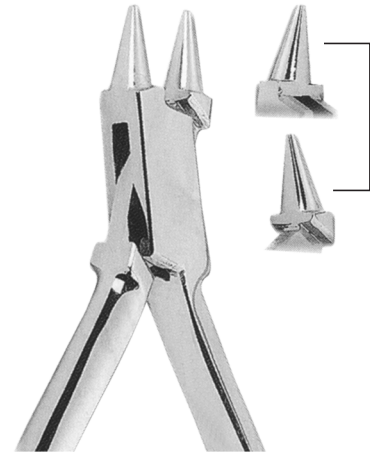

**VI-7033**

Double rounded jaw wire bending pliers. For wires up to 0,7 mm. (.028").



**VI-7034**

Bird beak pliers for bending round, square or rectangular wire up to 0,7 mm. (.028"). With cutter.



**VI-7035**

Double rounded jaw wire bending pliers. For wires up to 0,7 mm. (.028").



**VI-7036**  
USA Model  
125 mm



**VI-7037**  
Waldron  
125 mm



**VI-7038**  
How  
140 mm

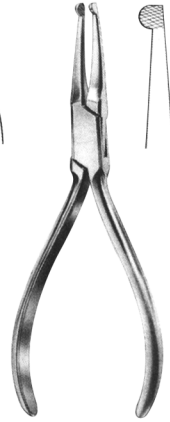

**VI-7039**  
How  
145 mm



**VI-7040**  
Adams  
125 mm



**VI-7041**  
Angle  
125 mm



**VI-7042**  
young  
130 mm



**VI-7043**  
Nance  
130 mm



**VI-7044**  
Weingart  
140 mm



**VI-7045**  
Johnson  
130 mm



**VI-7046**  
Mc Kellops  
155 mm

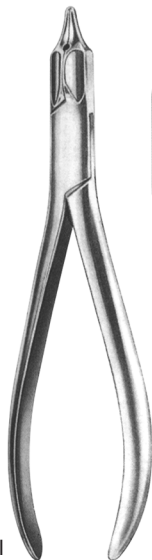

**VI-7047**  
Universal  
150 mm

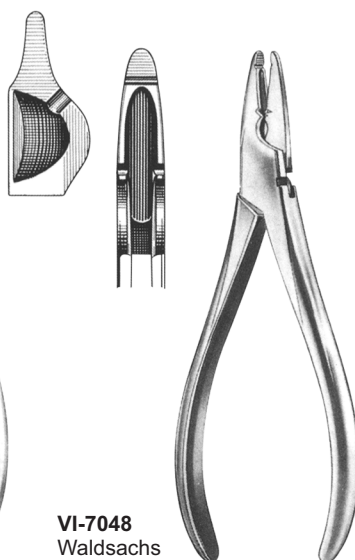

**VI-7048**  
Waldsachs  
155 mm

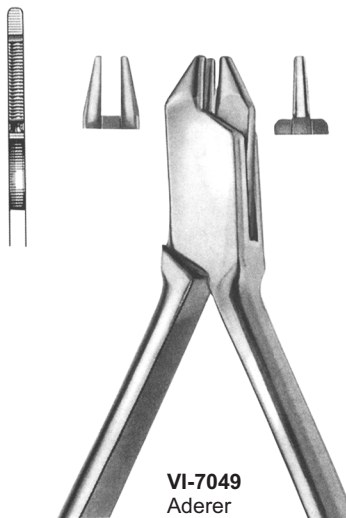

**VI-7049**  
Aderer  
125 mm



**VI-7050**  
Nance  
130 mm

Pliers for Othodontics and Prosthetics



**VI-7051**  
Langenbeck  
140 mm



**VI-7052**  
Langenbeck  
130 mm



**VI-7053**  
Langenbeck  
130 mm



**VI-7054**  
Peeso  
125 mm



**VI-7055**  
Goslee  
125 mm

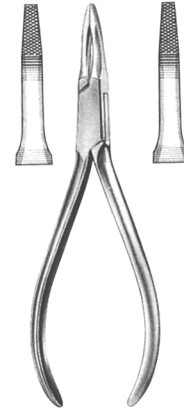

**VI-7056**  
Fischer  
140 mm

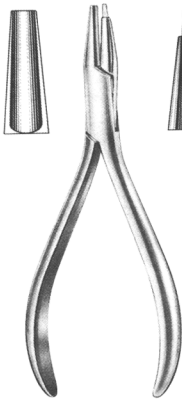

**VI-7057**  
Andresen  
130 mm

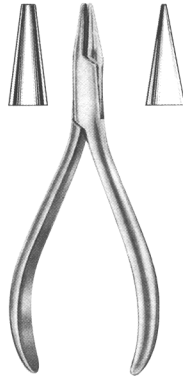

**VI-7058**  
Schwarz  
130 mm

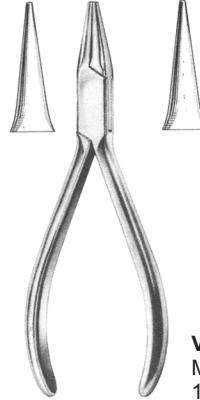

**VI-7059**  
MSY  
130 mm

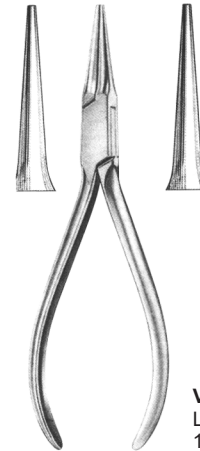

**VI-7060**  
Langenbeck  
125 mm



**VI-7061**

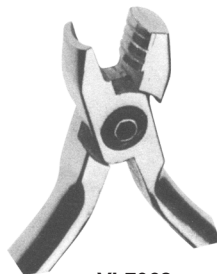

**VI-7062**

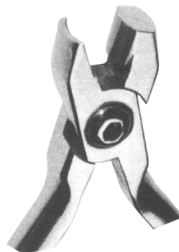

**VI-7063**

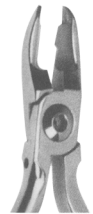

**VI-7064**

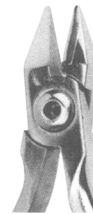

**VI-7065**



**VI-7066**



**VI-7067**



**VI-7068**



VI-7069

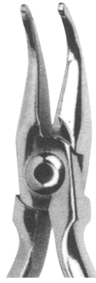

VI-7070

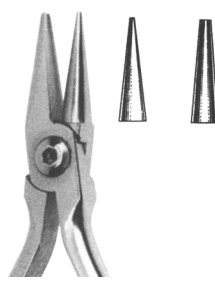

VI-7071

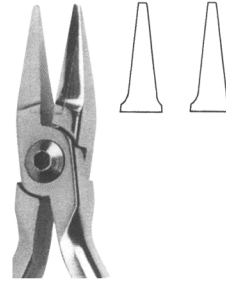

VI-7072

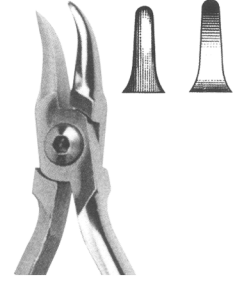

VI-7073

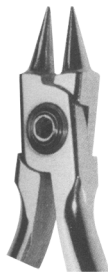

VI-7074

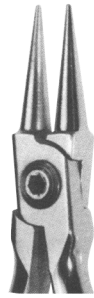

VI-7075

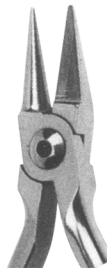

VI-7076

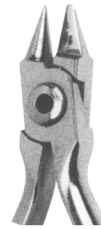

VI-7077



VI-7078

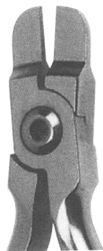

VI-7079

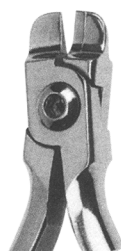

VI-7080

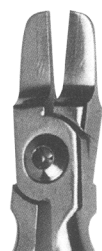

VI-7081

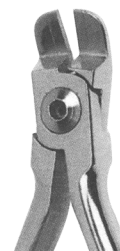

VI-7082

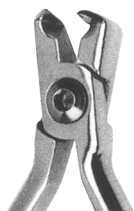

VI-7083

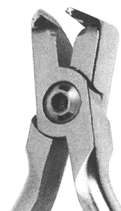

VI-7084

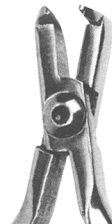

VI-7085

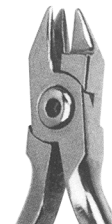

VI-7086



Mouth Gags



Molt  
**VI-7087** 10 cm  
**VI-7088** 11 cm  
**VI-7089** 14 cm

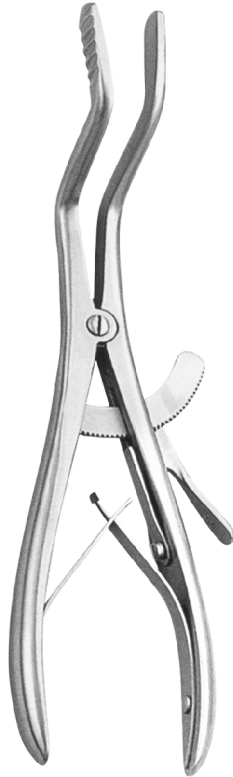

**VI-7090** 16 cm  
**VI-7091** 19 cm  
 Roser-König



**VI-7092**  
 Denhardt  
 13 cm



**VI-7093**  
 Fergusson - Ackland  
 14.5 cm



**VI-7094**  
 Heister  
 Maunder Wood  
 9.5 cm



**VI-7095**  
 Obwegeser 11 cm  
 Spreading 47 mm



**VI-7096**  
 Heister  
 13 cm



**VI-7097** Small  
**VI-7098** Medium  
**VI-7099** Large  
 Cheek Retractor

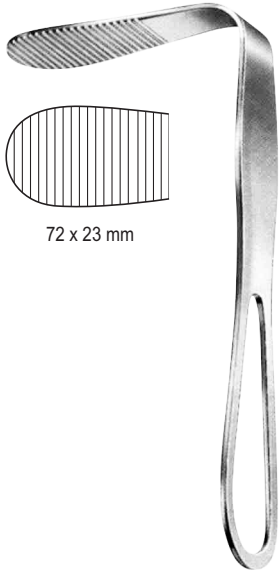

72 x 23 mm

**VI-7100**  
Hartmann  
15 cm



**VI-7101**  
Doyen Tongue Spatula  
13.5 cm



**VI-7102**  
14.5 cm



**VI-7103**  
18 cm



**VI-7104**  
Bruenings  
19 cm

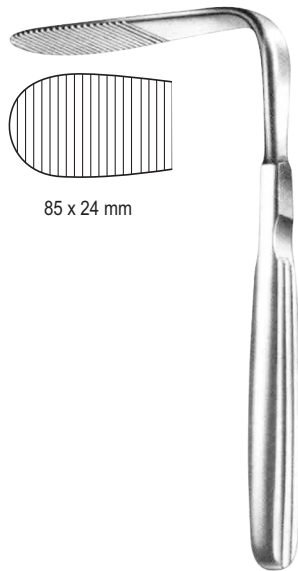

85 x 24 mm

**VI-7105**  
Tobold  
15 cm

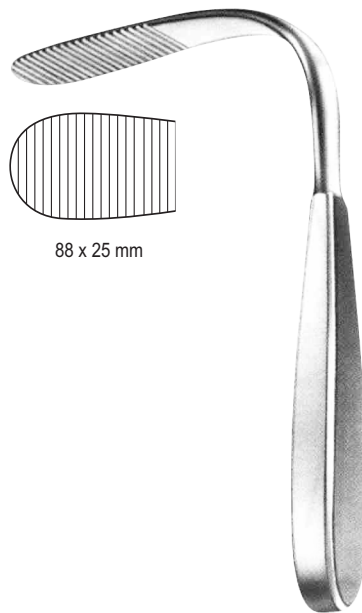

88 x 25 mm

**VI-7106**  
Tobold  
16 cm

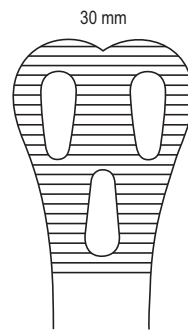

**VI-7107**  
14 cm

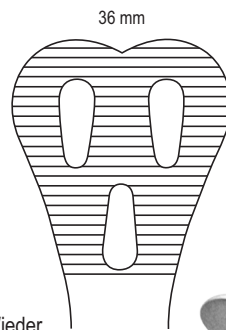

**VI-7108**  
15 cm

Wieder

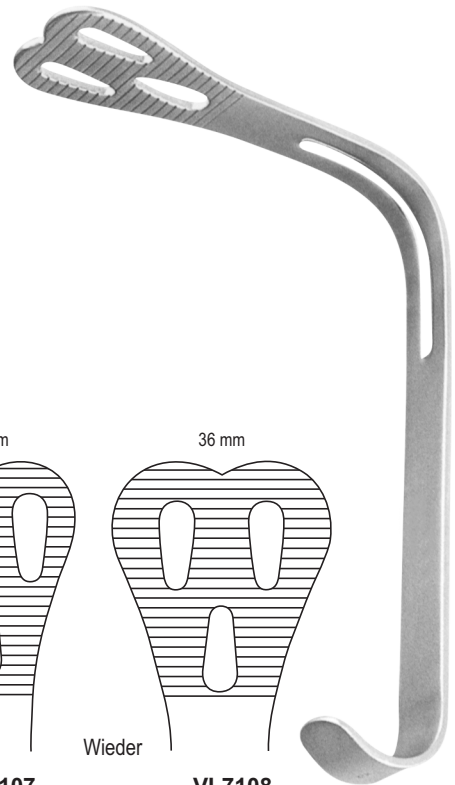

Lip and Cheek Retractors

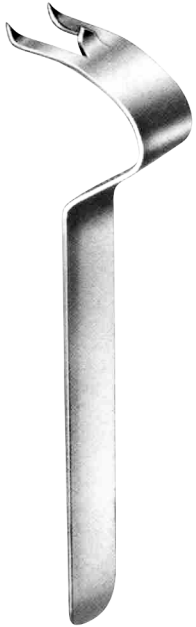

**VI-7109**  
Obwegeser Chin  
Retractor  
16.5 cm



Obwegeser 16 cm  
**VI-7110** 8 mm  
**VI-7111** 10 mm



**VI-7112** 43 x 11 mm  
**VI-7113** 57 x 11 mm  
**VI-7114** 83 x 16 mm



35 x 11 mm

**VI-7115**  
Obwegeser  
Spina-nasalis retractor  
22 cm



72 x 11 mm

**VI-7116**  
Obwegeser  
Ramus retractor for  
separation of ramus & tissue  
22 cm



**VI-7117**  
Simplex  
10.5 cm

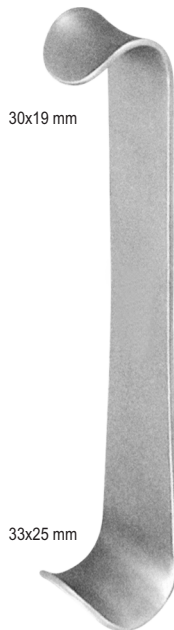

30x19 mm

33x25 mm

**VI-7118**  
Kilner  
15 cm



**VI-7119**  
Minnesota  
14 cm



**VI-7120**  
Cawood-Minnesota  
15 cm



**VI-7121**  
Austin





**VI-7122**  
Hilger  
Fits any simple stem mouth mirror handle



**VI-7123**  
Hilger  
with handle

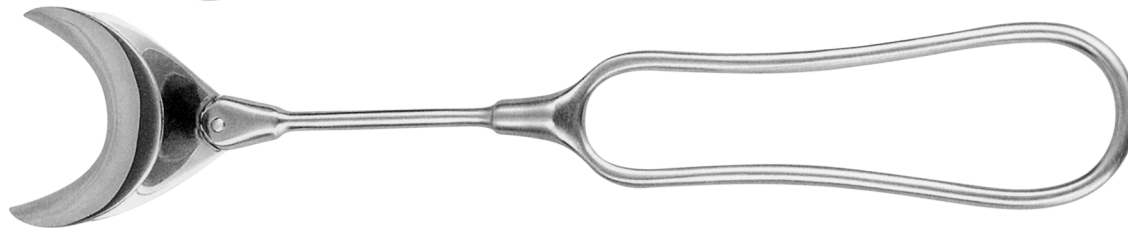

**VI-7124**  
Max  
20 cm

Finger protectors



Langenbeck

**VI-7125** Small  
**VI-7126** Medium  
**VI-7127** Large

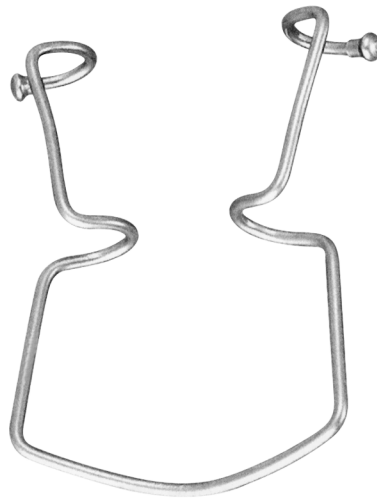

**VI-7128**  
Oringer  
11.5 cm

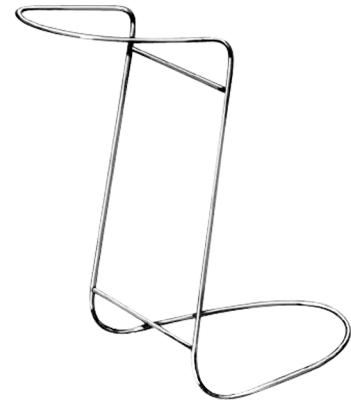

**VI-7129**  
Obwegeser Cheek Retractor  
12cm

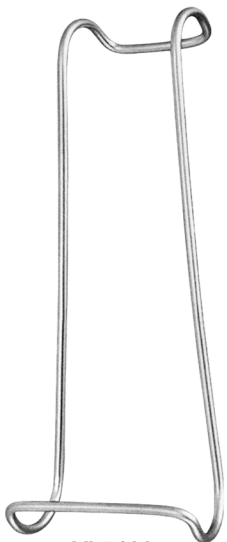

**VI-7130**  
Columbia  
14.5 cm



**VI-7131** 12 cm  
**VI-7132** 14 cm  
**VI-7133** 15 cm  
Sternberg



Vestibulum  
**VI-7134**



**VI-7135**  
Max

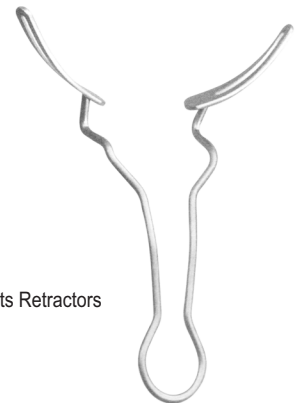

Implants Retractors

**VI-7136**  
Max

Retractors

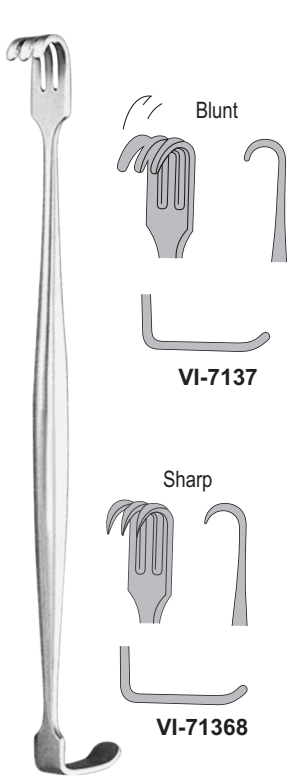

Senn-Miller  
16 cm



Max  
16 cm



Sharp  
VI-7140



VI-7141



VI-7142



Max  
16 cm



Blunt  
VI-7143



VI-7144



VI-7145



VI-7146

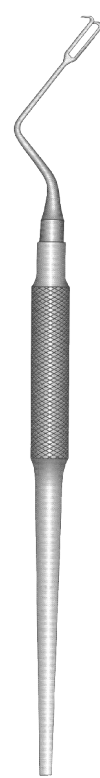

Kirkland  
Gum & Tissue  
Retractors



VI-7147  
Fig. 23 K



VI-7148  
Fig. 24 K

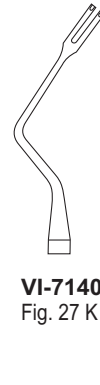

VI-7140  
Fig. 27 K

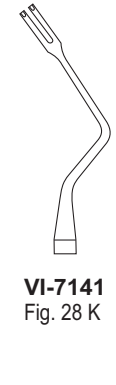

VI-7141  
Fig. 28 K



VI-7142  
Collin Tongue holding forcep  
17 cm



Young Tongue holding forcep  
VI-7144 15 cm  
VI-7145 17 cm

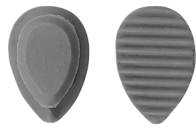

VI-7143  
Rubber Pad pair

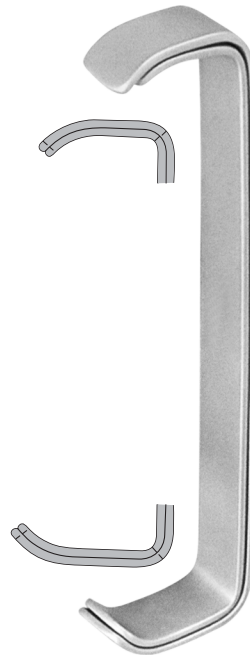

VI-7146  
Farabeuf 12 cm  
Pair

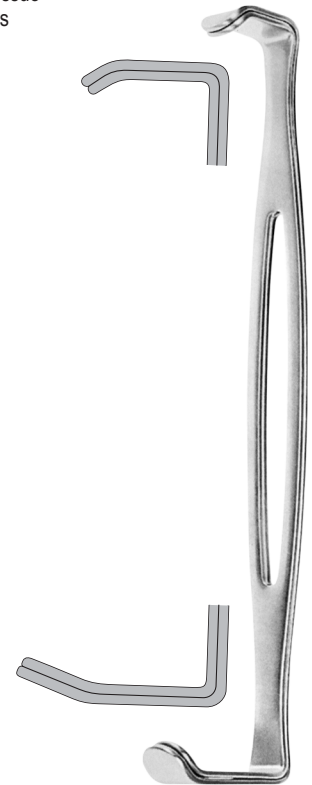

VI-7147  
Parker-Langenbeck 21 cm  
Pair

Osteotomes



15.5 cm

# 1	Diam.
0	Ø 1.60
7.5	Ø 1.80
10	Ø 2.00
13.5	Ø 2.40
15.5	Ø 3.60

# 1

Ø 1.6 mm



**VI-7148**  
15.5 cm

# 2	Diam.
0	Ø 1.90
7.5	Ø 2.20
10	Ø 2.35
13.5	Ø 3.30
15.5	Ø 3.40
23.5	Ø 4.50

# 2

Ø 1.9 mm



**VI-7149**  
15.5 cm

# 3	Diam.
0	Ø 2.80
7.5	Ø 3.20
10.5	Ø 3.35
13.5	Ø 3.60
21	Ø 4.40

# 3

Ø 2.8 mm



**VI-7150**  
15.5 cm

# 4	Diam.
0	Ø 3.10
7.5	Ø 3.70
10.5	Ø 3.90
15.5	Ø 4.30

# 4

Ø 3.10 mm



**VI-7151**  
15.5 cm

# 5	Diam.
0	Ø 3.90
10	Ø 5.00
13	Ø 5.20
20.5	Ø 6.30

# 5

Ø 3.90 mm



**VI-7152**  
15.5 cm

# 6	Diam.
0	Ø 5.50
10	Ø 6.20
13	Ø 6.30

# 6

Ø 5.50 mm



**VI-7153**  
15.5 cm

# 1	Diam.
0	Ø 1.50
5	Ø 1.90
8	Ø 2.20
10	Ø 2.40
12	Ø 2.60
14	Ø 2.80

# 1  
Ø 1.5 mm



**VI-7154**  
15.5 cm

# 2	Diam.
0	Ø 2.10
5	Ø 2.60
8	Ø 2.80
10	Ø 3.00
12	Ø 3.20
14	Ø 3.40

# 2  
Ø 2.1 mm



**VI-7155**  
15.5 cm

# 3	Diam.
0	Ø 2.60
5	Ø 3.00
8	Ø 3.30
10	Ø 3.50
12	Ø 3.70
14	Ø 3.90

# 3  
Ø 2.6 mm



**VI-7156**  
15.5 cm

# 4	Diam.
0	Ø 3.00
5	Ø 3.50
8	Ø 3.80
10	Ø 4.00
12	Ø 4.20
14	Ø 4.40

# 4  
Ø 3.0 mm



**VI-7157**  
15.5 cm

# 5	Diam.
0	Ø 3.50
5	Ø 3.90
8	Ø 4.20
10	Ø 4.40
12	Ø 4.60
14	Ø 4.80

# 5  
Ø 3.5 mm



**VI-7158**  
15.5 cm

Ø 2.8 mm



**VI-7159**  
15.5 cm

Ø 3.5 mm

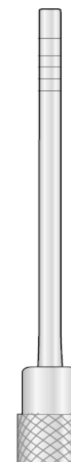

**VI-7160**  
15.5 cm

Ø 4.2 mm



**VI-7161**  
15.5 cm

Spelling Straight  
Bone Pusher

Osteotomes

INDUSTRIES



15 cm

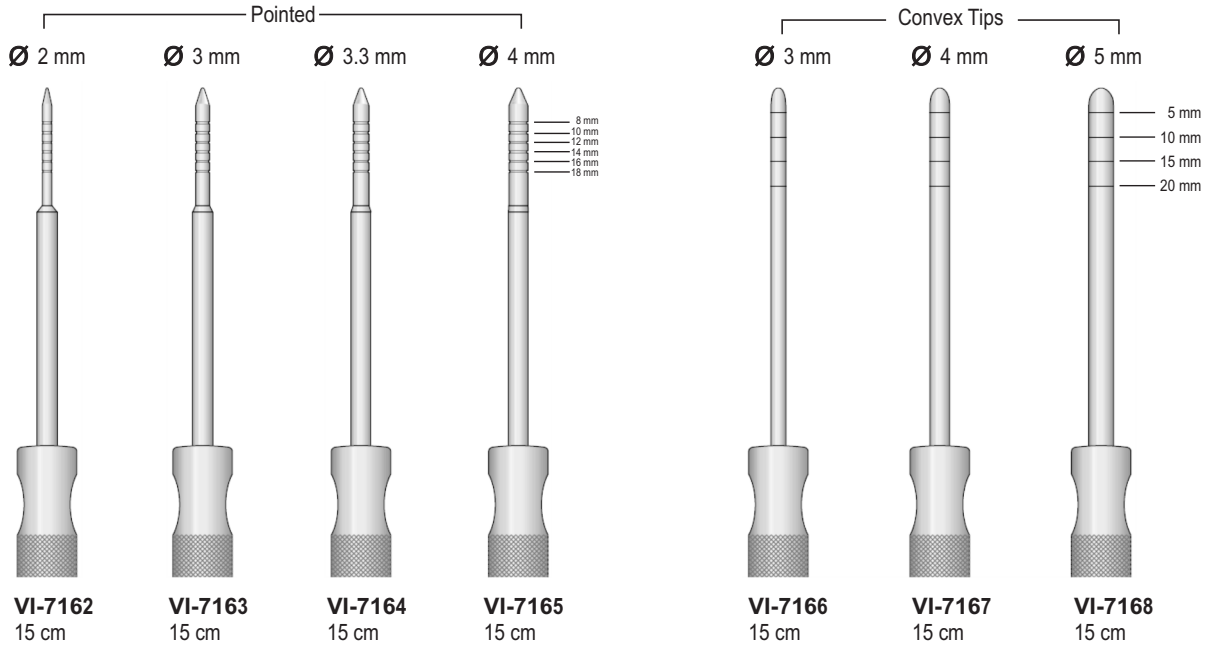

Convex Tips



16.5 cm  
Str

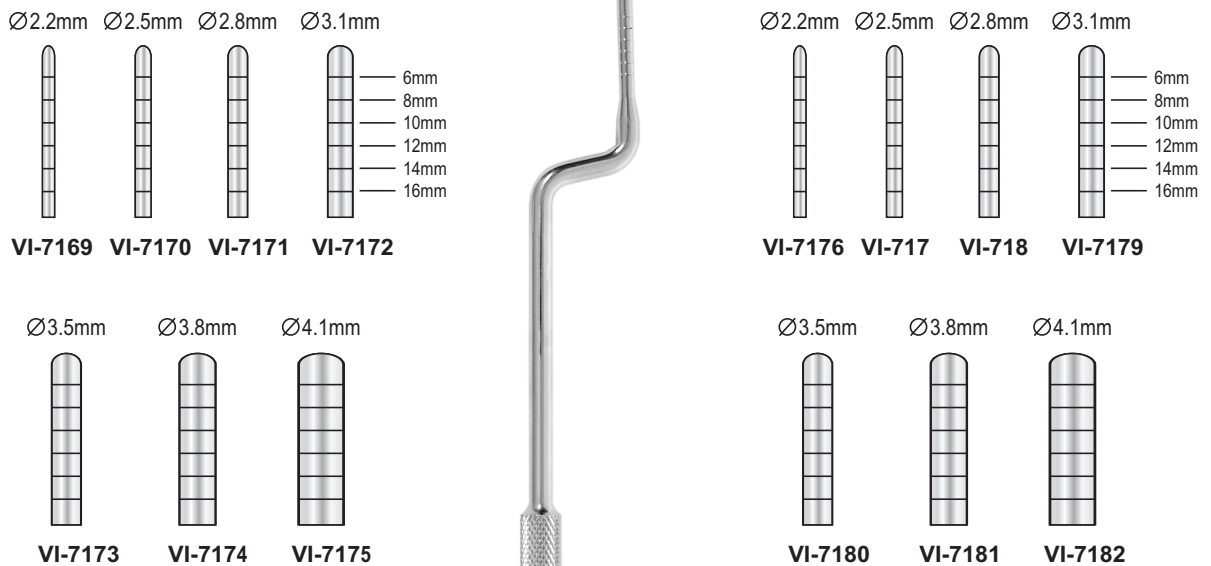

16.5 cm  
Cvd

	Concave				Osteotomes with Stop				Concave								
	Ø2mm	Ø3mm	Ø3.3mm	Ø4mm		Ø2mm	Ø3mm	Ø3.3mm	Ø4mm		Ø2mm	Ø3mm	Ø3.3mm	Ø4mm			
				6mm 11mm 15mm				6mm 11mm 15mm				6mm 11mm 15mm					
	Convex				Concave				Convex								
	Ø2mm	Ø3mm	Ø3.3mm	Ø4mm		Ø2mm	Ø3mm	Ø3.3mm	Ø4mm		Ø2mm	Ø3mm	Ø3.3mm	Ø4mm			
				6mm 11mm 15mm				6mm 11mm 15mm				6mm 11mm 15mm					
	Pointed				Concave				Pointed								
	Ø2mm	Ø3mm	Ø3.3mm	Ø4mm		Ø2mm	Ø3mm	Ø3.3mm	Ø4mm		Ø2mm	Ø3mm	Ø3.3mm	Ø4mm			
				6mm 11mm 15mm				6mm 11mm 15mm				6mm 11mm 15mm					
	Concave				Osteotomes with Stop				Concave								
	Ø2.5mm	Ø3mm	Ø3.8mm	Ø4.5mm	Ø5mm		Ø2.5mm	Ø3mm	Ø3.8mm	Ø4.5mm	Ø5mm		Ø2.5mm	Ø3mm	Ø3.8mm	Ø4.5mm	Ø5mm
				8mm 11mm 13mm 15mm 17mm 20mm				8mm 11mm 13mm 15mm 17mm 20mm				8mm 11mm 13mm 15mm 17mm 20mm					
	Convex				Concave				Convex								
	Ø2.5mm	Ø3mm	Ø3.8mm	Ø4.5mm	Ø5mm		Ø2.5mm	Ø3mm	Ø3.8mm	Ø4.5mm	Ø5mm		Ø2.5mm	Ø3mm	Ø3.8mm	Ø4.5mm	Ø5mm
				8mm 11mm 13mm 15mm 17mm 20mm				8mm 11mm 13mm 15mm 17mm 20mm				8mm 11mm 13mm 15mm 17mm 20mm					
	Pointed				Concave				Pointed								
	Ø2.5mm	Ø3mm	Ø3.8mm	Ø4.5mm	Ø5mm		Ø2.5mm	Ø3mm	Ø3.8mm	Ø4.5mm	Ø5mm		Ø2.5mm	Ø3mm	Ø3.8mm	Ø4.5mm	Ø5mm
				8mm 11mm 13mm 15mm 17mm 20mm				8mm 11mm 13mm 15mm 17mm 20mm				8mm 11mm 13mm 15mm 17mm 20mm					



Implantology Instruments



VI-7177 Distal, 2.5 mm Micro Edge

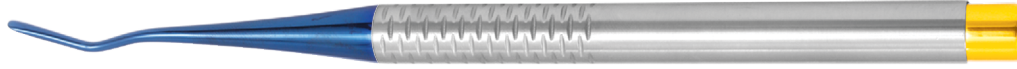

VI-7178 Mesial, 2.5 mm Micro Edge

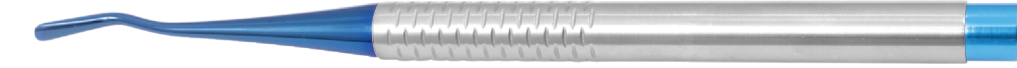

VI-7179 Distal, 4 mm Micro Edge



VI-7180 Mesial 4 mm Micro Edge



VI-7181 2.5 mm Micro Edge, Straight

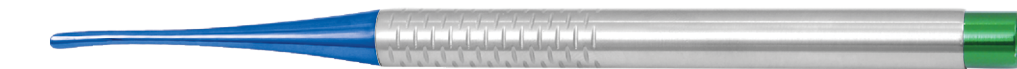

VI-7182 2.5 mm Micro Edge, Curved



VI-7183 3.4 mm Straight

VI-7184 Set Of 7 Pieces



VI-7185 Distal, 2.5 mm Micro Edge

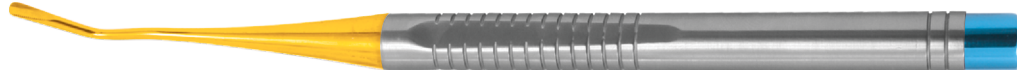

VI-7186 Mesial, 2.5 mm Micro Edge



VI-7187 Distal, 4 mm Micro Edge



VI-7188 Mesial 4 mm Micro Edge



VI-7189 2.5 mm Micro Edge, Straight



VI-7190 2.5 mm Micro Edge, Curved

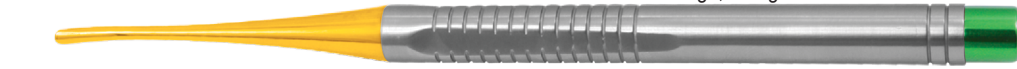

VI-7191 3.4 mm Straight

VI-7192 Set Of 7 Pieces



Instruments Tray

Trephine Drills

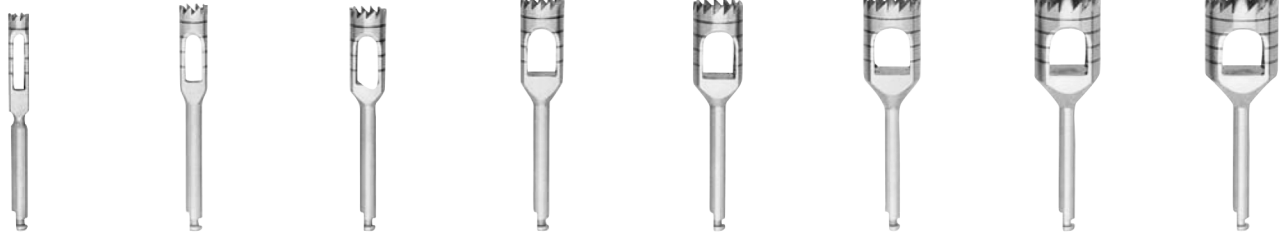

- |  |  |  |  |  |  |  |   |
|--|--|--|--|--|--|--|---|
| <b>VI-7193</b><br>Interior 2 mm<br>Exterior 3 mm | <b>VI-7194</b><br>Interior 3 mm<br>Exterior 4 mm | <b>VI-7195</b><br>Interior 4 mm<br>Exterior 5 mm | <b>VI-7196</b><br>Interior 5 mm<br>Exterior 6 mm | <b>VI-7197</b><br>Interior 6 mm<br>Exterior 7 mm | <b>VI-7198</b><br>Interior 7 mm<br>Exterior 8 mm | <b>VI-7199</b><br>Interior 8 mm<br>Exterior 9 mm | <b>VI-7200</b><br>Interior 9 mm<br>Exterior 10 mm |
|--|--|--|--|--|--|--|---|

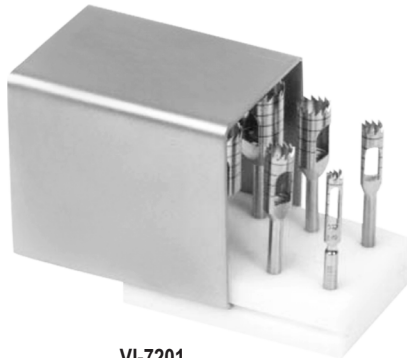

**VI-7201**  
Trephine Drills Stand  
Complete with drills



**VI-7202**  
Trephine Drills Stand  
Complete with drills

Tissue Punches

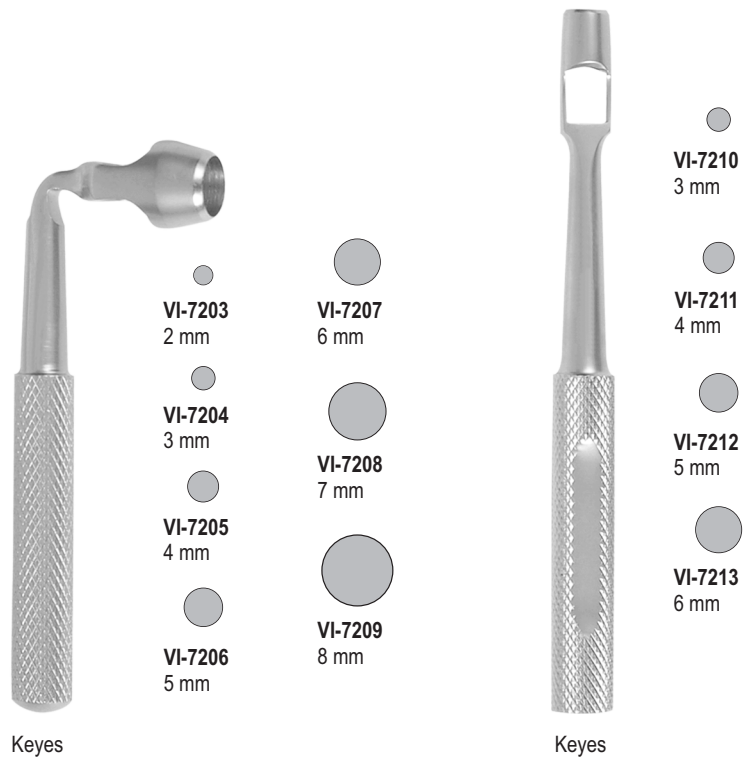

Keys

Keys



**VI-7214**  
Bone Collector Chisel Straight



**VI-7215**  
Blade for Straight bone collector chisel



**VI-7216**  
Bone Collector Chisel Curved



**VI-7217**  
Blade for Curved bone collector chisel



**VI-7218**  
Ratchet Screw driver handle  
Hexagonal head

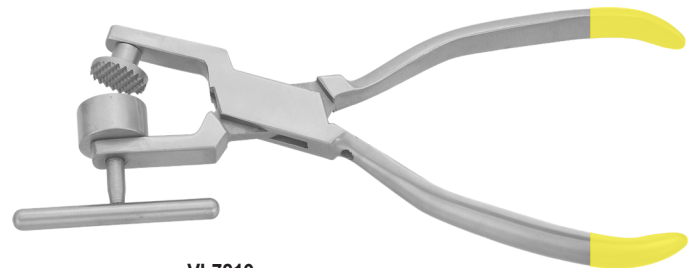

**VI-7219**  
Bone Morselizer with Titanium Grinding



**VI-7220**  
Bone Mixing Basin  
Dia 35 mm



**VI-7221**  
Manual Easy Bone Mill



**VI-7222**  
Bone Craker Titanium



All Impression Trays Upper & Lower Type are available in S, M, L & XL Sizes



**VI-7223**  
"HYDRO-LOCK"  
stainless steel  
water-cooled  
impression trays  
with retention rim.

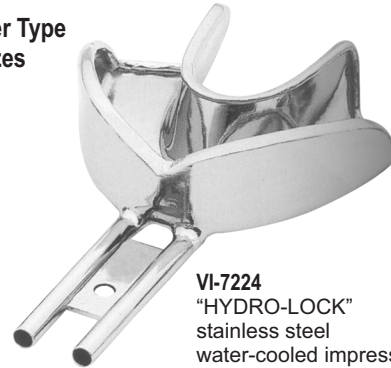

**VI-7224**  
"HYDRO-LOCK"  
stainless steel  
water-cooled impression  
trays with retention rim.



**VI-7225**  
"NEW SUPER"  
stainless steel  
impression trays  
with retention rim.



**VI-7226**  
"NEW SUPER" stainless  
steel impression trays  
with retention rim.



**VI-7227**  
"ANATOMIC" solid  
regular stainless  
steel impression  
trays without  
retention rim.



**VI-7228**  
"ANATOMIC" solid regular  
stainless steel impression  
trays without retention rim.

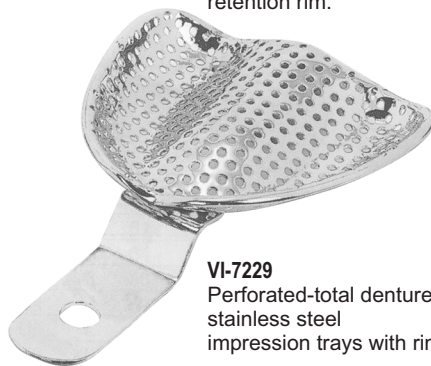

**VI-7229**  
Perforated-total denture  
stainless steel  
impression trays with rim.



**VI-7230**  
Perforated-total denture  
stainless steel  
impression trays with rim.

Stainless Steel Impression Trays

All Impression Trays Upper & Lower Type are available in S, M, L & XL Sizes



**VI-7231**  
"PERMA-LOCK" solid regular stainless steel impression trays with retention rim.



**VI-7232**  
"PERMA-LOCK" solid regular stainless steel impression trays with retention rim.



**VI-7233**



**VI-7234**



**VI-7235**



**VI-7236**



**VI-7237**

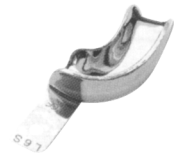

**VI-7238**



**VI-7239**  
Set of six

PACKINGS



**VI-7240**  
Set of Eight



**VI-7241**  
Solid stainless steel anterior depressed impression trays with retention rim.



**VI-7242**



**VI-7243**



**VI-7244**



**VI-7245**



**VI-7246**



**VI-7247**



**VI-7248**  
Solid stainless steel anterior depressed impression trays with retention rim.

All Impression Trays Upper & Lower Type are available in S, M, L & XL Sizes



**VI-7249**  
Fig. 0 per bambini - for children

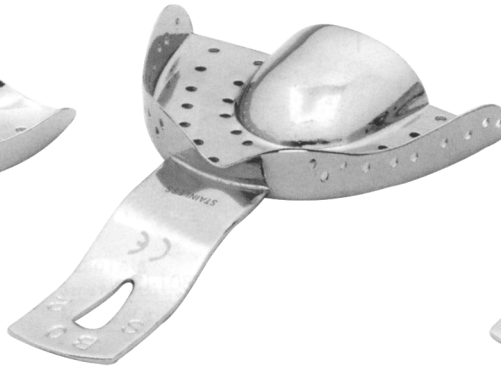

**VI-7250**  
For narrow toothed upper jaws



**VI-7251**  
Fig. 0 per bambini - for children



**VI-7252**  
For partially toothed upper jaws



**VI-7253**  
For partially toothed lower jaws



**VI-7254**  
For edentulous upper jaws



**VI-7255**  
For edentulous lower jaws

Stainless Steel Impression Trays

All Impression Trays Upper & Lower Type are available in S, M, L & XL Sizes



**VI-7256**  
Solid total denture stainless steel impression tray with rim.

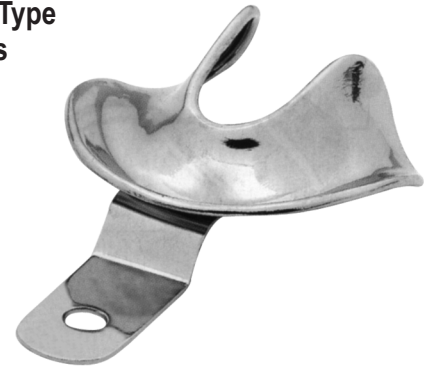

**VI-7257**  
Solid total denture stainless steel impression tray with rim.



**VI-7258**  
"PERMA-LOCK" perforated regular stainless steel impression trays with retention rim.



**VI-7259**  
"PERMA-LOCK" perforated regular stainless steel impression trays with retention rim.



**VI-7260**  
Perforated stainless steel anterior depressed impression trays with retention rim.



**VI-7261**



**VI-7262**

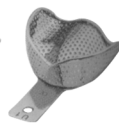

**VI-7263**



**VI-7264**



**VI-7265**



**VI-7266**



**VI-7267**  
Perforated stainless steel anterior depressed impression trays with retention rim.



**VI-7268**  
Perforated stainless steel impression trays without retention rim for complete denture.



**VI-7269**  
Perforated stainless steel impression trays without retention rim for complete denture.



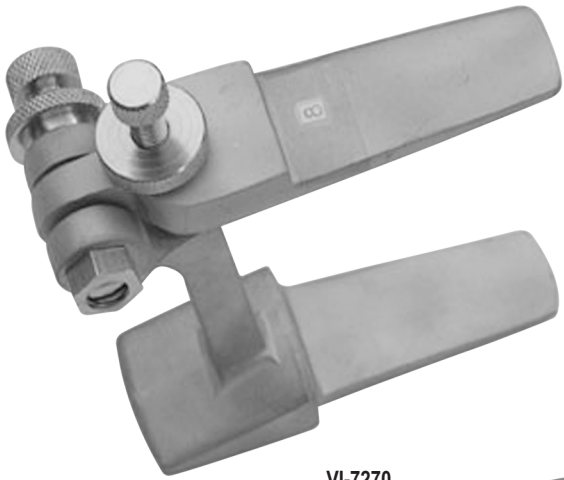

VI-7270



VI-7271



VI-7272



VI-7273

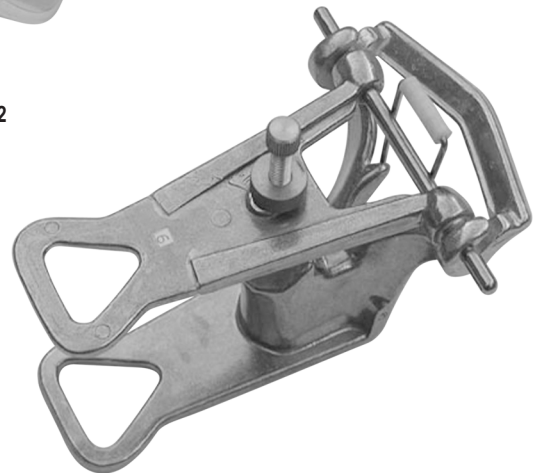

VI-7274



VI-7275

Articulators

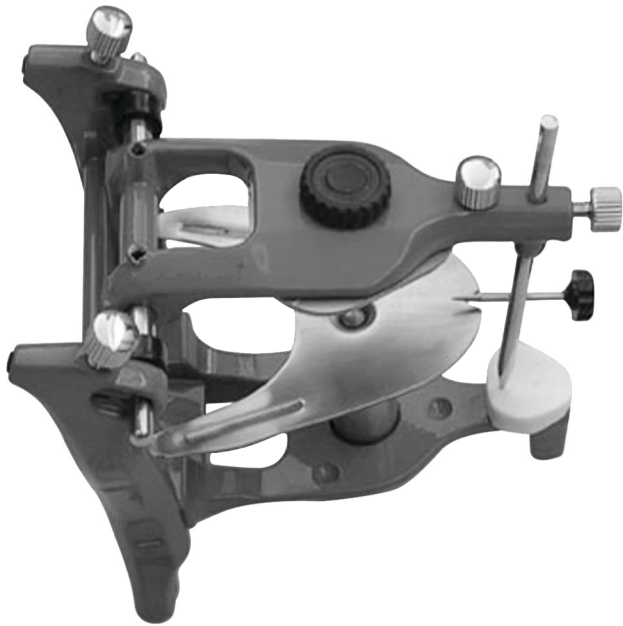

VI-7276



VI-7277



VI-7278



VI-7289



**VAKMAN**  
INDUSTRIES

**08**

**Page**  
**159-161**

▪ Hollowares

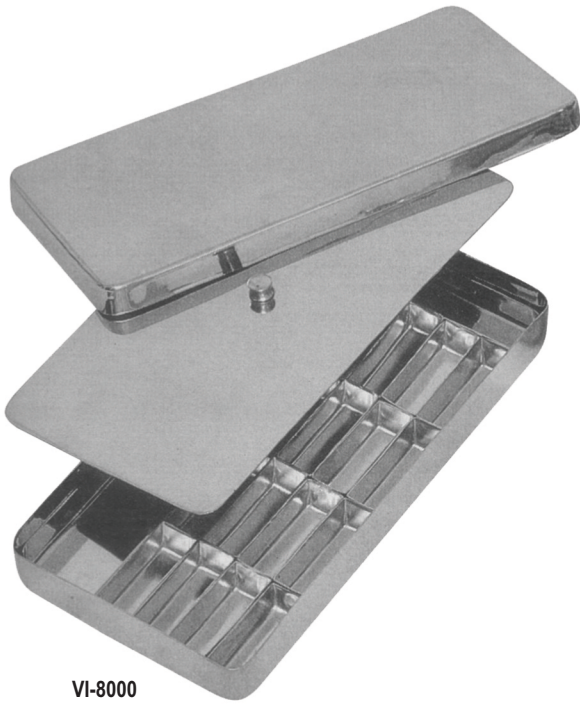

**VI-8000**  
**ENDODONTIC BOX**

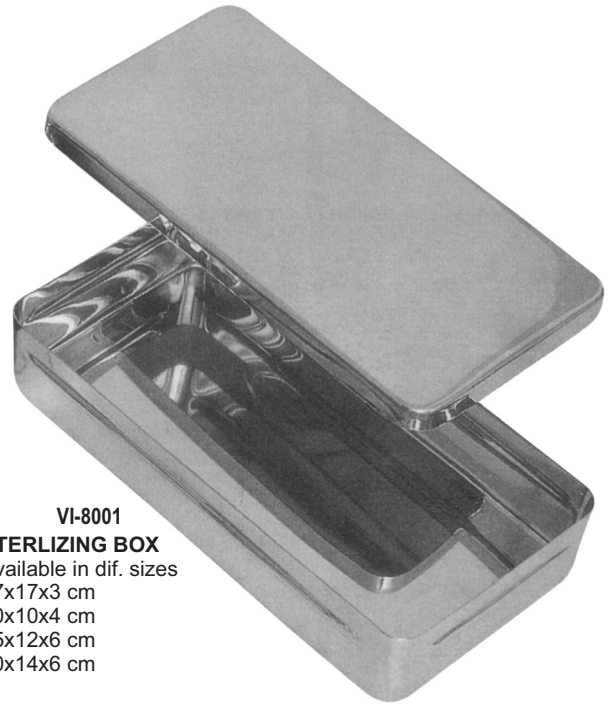

**VI-8001**  
**STERILIZING BOX**  
Available in dif. sizes  
17x17x3 cm  
20x10x4 cm  
25x12x6 cm  
30x14x6 cm



**VI-8002**  
**ENDO TRAY BOX**

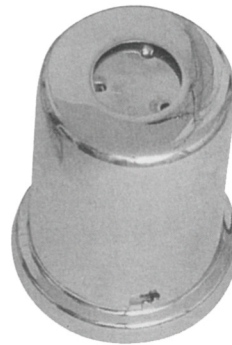

**VI-8003**  
**COTTON DISPENSER**

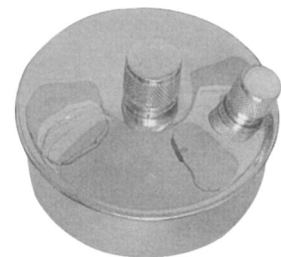

**VI-8004**  
**ALCOHOL LAMP**

**Sterilizing Drums**



**VI-8005**



**VI-8006**



**VI-8007**



**Sterilizing Boxes**



VI-8008



VI-8009



VI-8010

**Sterilizing Boxes**



VI-8011



VI-8012



VI-8013



VI-8014



VI-8015



VI-80106

**FORCEP AND THERMOMETER JARS**

**COTTON DISPENSER**



VI-8017  
IRRIGATOR(Douch can)



VI-8018  
MEASURING JUG

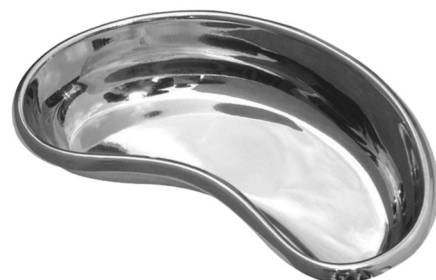

VI-8019  
KIDNEY TRAY



VI-8020  
FORCEP JAR



VI-8021  
GALLIPOT WITH & WITHOUT LID



VI-8022  
SPITTEN MUG



VI-8023  
SPIRIT LAMP

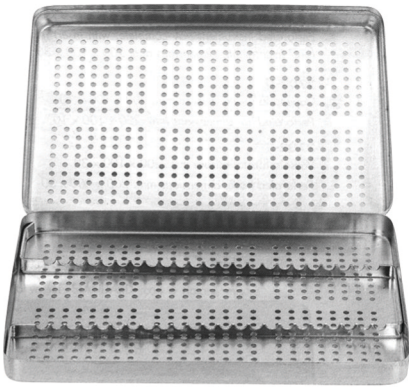

VI-8024  
Perforated Tray



VI-8025  
Perforated Base



VI-8026  
Solid Base



VI-8027  
Instruments Tray



VI-8028  
Instruments Tray



VI-8029  
Instruments Tray  
(Perforated)



VI-8030  
Instruments Tray Shallow  
(Mayo)



VI-8031  
Scalers Tray



VI-8032  
Cathetar Tray

## Alphabetical Index

<b>A</b>		
Adams	125, 133	
Aderer	133	
Adson	96	
Ainsworth	110	
Albee	77	
Albrecht	109	
Alcohol Lamp	142	
Alginate	93-94	
Allen	109	
Amalgam Carriers	117	
Amalgam Guns	117	
Amalgam Well	117	
Andresen	134	
Angle	133	
Antkoviak	78	
Apical	36, 44	
Arruga	97	
Articulators	140	
Ash	53, 88	
Aspirating Syringes	102	
<b>B</b>		
Band Adaptor	102	
Barry	47, 50	
Baumgarthner	96	
Beale	76	
Beebee	116	
Bein	33, 40	
Bennet	53, 123	
Beyer	121	
Bicuspids	114	
Birdbeak Pliers	132	
Blumenthal	120, 121	
Bohler	120	
Bohm	118	
Boley	77	
Bone Chisels	68	
Boynton	97	
Breech Loading Syringe	102	
Brewer	110	
Buck	61-63, 65	
Buckley	67, 124	
Burnishers	58	
<b>C</b>		
Caroll	77	
Castroviejo	77, 98, 100	
Cathetar Tray	144	
Cement Spatulas	91, 92	
Chompret	44	
Ck1	108	
CK2	108	
Cleveland	122	
College	105, 107	
Columbia	64, 66, 74	
Columbia	79	
Cone-Socket	90	
Cork Screw Tip	104	
Cotton Dispenser	142, 143	
Coupland	37	
Crane-kaplan	74	
Crile-Wood	96	
Crown Removers	115-116	
Cryer	35, 37, 48	
Curette	64, 66	
<b>D</b>		
De La Rosa	129	
Dental Probes	57	
Dental Syringes	103-104	
Derf	95	
Didner	113	
<b>E</b>		
Eliselberg-Mathieu	97	
Elliott	53	
Endo Finger Ruler	102	
Endo Tray Box	142	
Endodontic Box	142	
Ermert	78	
Excavators	87-88	
Explorers	81	
Extracting Forceps	01-31	
<b>F</b>		
Fahnenstock	79	
Filling Instruments	52-56	
Fischer	134	
Flagg	107	
Flohr	38	
Forcepps Jar	143, 144	
Fox	58	
Fraizer	100	
Freer	123	
Friedman	119-120	
Furrer	119	
<b>G</b>		
Gallipot	144	
Gardner	67, 122	
GF1	108	
GF2	108	
Gillies	96	
Goldman Fox	60, 63, 65, 73, 120	
Goslee	134	
Gouges	68	
Gracey Curettes	69	
Gracey Mesial Distal	69	
Gracey	56-69-72	
Gritman	76-78-80	
<b>H</b>		
Halstead-Mosquito	118	
Hegar-Baumgartner	95-96	
Heidbrink	45-48-50	
Heidemann	55	
Hemingway	75	
Henahan	123	
How	133	
Hylin	40, 76	
<b>I</b>		
Impression Trays	136-139	
Intra-Ligamental Syringes	104	
Irrigator	143	
Ivory	110, 113	
Iwanson	77	
<b>J</b>		
Jaquette	74	
Johnson	133	
<b>K</b>		
Kelly	118	
Kerrison	120	
Kidney Tray	143	
Kilian	124	
Kilian-Claus	124	
Klein	07	
Kleinert-Kutz	121	
Kopp	39, 49, 108	
<b>L</b>		
Landgraf	107	
Langenbeck	134	
Le Cron	76	
Lecluse	43	
Lessmann	79	
Lichtenberg	97	
Listion-mini	122	
London Hospital	41	
London-College	107, 109	
Lucas	75	
Luer	120	
Luks	84	





<b>M</b>			<b>R</b>		
Machtou	83	Rhodium	89	Rein	81
Mallets	68	Roach	76	Relax	05
Mathieu	99, 100	Root Elevators	32--51	Reynolds	129
Matrix Bands	113, 114	Root Splinter	31	Rhodes	61, 62
Matrix Retainers	113	Root-Canal Excavators	86		
Mayo-Hegar	95	Root-Canal Explorers	86		
Mc Call	73	Root-Canal Plungers	84-85		
Mc Kellops	133	Rubber Dam Clamps	111-112		
Mead	43, 58, 119	Rubber Dam Frame	110		
Measuring Jug	143	Ruskin-Mini	121		
Measuring Plate	84				
Medicon	78	<b>S</b>			
Meriam	106, 109	Scalers	58		
Merrit A	60	Schell	119		
Mershon	110, 116	Schilder	85		
Micro-Barraquer	99-100	Schluger	61, 62		
Micro-Mosquito	118	Schwarz	134		
Miller	118, 124	Seldin	34, 48, 123		
Mini-Ryder	95	Spirit Lamp	144		
Molar	114	Spitten Mug	144		
Morell	116	Spreader	82-83		
Mouth Mirror Handles	89, 90	Sterilizing Boxes	142, 143		
Mouth Mirrors	89, 90	Sterilizing Drums	142		
MSY	76, 134	Sugarman	61, 162		
<b>N</b>			<b>T</b>		
Nabers	83	Taylor	74		
Nance	128, 133	Toennis	97		
Niro	122	Tofflemire	114		
		Tofflemire-Junior	113		
<b>O</b>					
Obwegeser	124	Tofflemire-Senior	113		
Ochsenbein	61, 62, 67	Tofflemire-Universal	113		
Olsen-Heger	96	Towner Jaquette	74		
Oms	83	Towner	74		
Ott	41	Trays	144		
		Treyman	116		
<b>P</b>					
P	76	Tweed	130		
P.K. Thomas	68				
Partsch	134	<b>U</b>			
Pocket Probes	58-60	Univarsal "HM"	116		
Plaster Knives	80	Univarsal	128, 133		
Plaster Spatulas	93-94	University of Michigan	60		
Position Gauge	102	USA Model	133		
Pott	42				
<b>R</b>			<b>V</b>		
Rein	81	Vehe	76		
Relax	05	Vernier	77		
Reynolds	129	Vertical Condenser	83		
Rhodes	61, 62				
<b>W</b>					
Wakefield	67				
Waldron	67				
Waldsachs	133				
Warwick-James	130, 133				
Water Syringe	41				
Weingart	101				
White	129, 133				
Williams	52, 60, 83				
Williger	123				
Winter	46, 50				
Woodson	54, 55				
<b>Y</b>					
Young	133				
Younger-Good	73				
<b>Z</b>					
Zahle	76				
Zaufal-Jansen	121				
Zerfing-Chisel	64, 66				
Zuricher	77				



**VAKMAN** INDUSTRIES



Jinnah Islamia Collage Road  
Sialkot - 51310 Pakistan.

+92 52 4593350



+92 52 4594276

+92 52 4593849



+92 52 4588276



[info@vakman.com.pk](mailto:info@vakman.com.pk)



[www.vakman.com.pk](http://www.vakman.com.pk)